

**Sabelt**

[www.sabelt.com](http://www.sabelt.com)

 @sabeltofficial  
 sabeltofficial  
 Sabelt S.p.A.

Sabelt S.p.A.  
Via Guido Rossa, 8/10/12  
10024 Moncalieri (TO) Italia

Tel. +39 011 6477911  
Fax +39 011 6477999  
[info@sabelt.com](mailto:info@sabelt.com)

CATALOGUE 2022

  
1 9 7 2 - 2 0 2 2  
**CATALOGUE 2022**

**Sabelt**

## 70s

Market leader  
in seatbelts production.

## 1972

Piero and Giorgio Marsiaj founded Sabelt.  
Sabelt stands for "Safety belt".

**sabelt**

## 80s

International  
expansion.

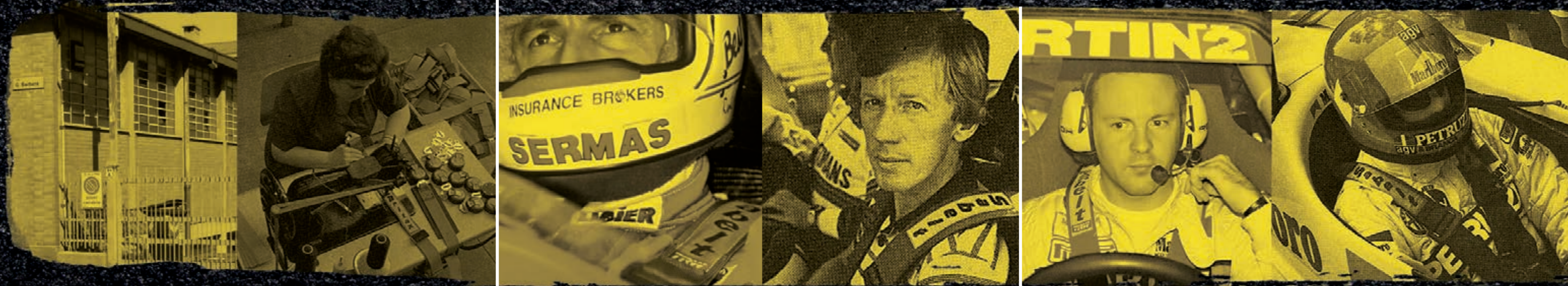

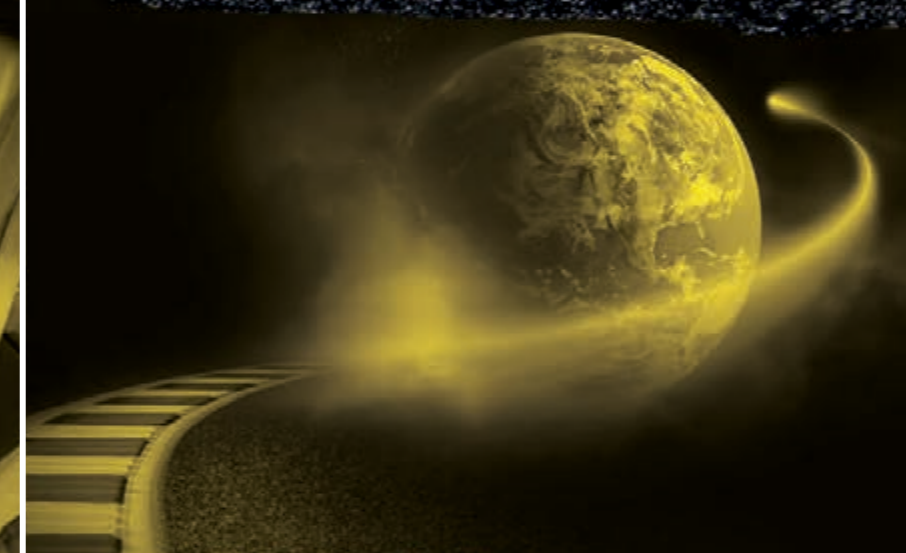

## 90s

Sabelt expanded the range of products with the addition of suits, seats and accessories for motorsport.

## 2000s

First OEM sport seat - Ferrari.

## TODAY

FROM F1 TO SPACE

3 business units:

- Racing
- Automotive Seating
- Special Applications.

**Sabelt**

READY FOR THE NEXT  
CHALLENGE!





**Sabelt**<sup>®</sup>

**12**

**HARNESSES**

**58**

**NETS**

**60**

**SEATS**

**104**

**RACEWEAR**

**134**

**STEERING WHEELS**

**138**

**ACCESSORIES**

# THE COMPANY



Sabelt, founded in 1972 by Piero and Giorgio Marsiaj, specializes in the development and production of car seats for performance road cars, racing products for motor racing and seatbelts for aerospace. The quality of Sabelt products is the result of intense research and development, which allows it to reach the highest levels of performance and safety. Sabelt invests 8% of its resources annually in research and development and is the only company in its sector to have an internal dynamic test laboratory to perform ECE and FIA tests, aimed at verifying the strength and effectiveness of its products.

## HERITAGE



We have provided the top historical car manufacturers with innovative restraint systems for decades.

## SAFETY



For Sabelt, safety is of the utmost importance: first in the car, supplying the best seat belts in the world, second for drivers all over categories and championships.

## DESIGN



Sabelt offers high performance levels integrated with style and design. Each component is designed and engineered either exclusively by Sabelt in support with external Design&Style centres or in partnership with the client.

## INNOVATION



We transform ideas into products. We collaborate with our customers to study new and better solutions and meet specific needs and new requirements. All our products are the result of a process that brings together various novel ideas with engineering and technology.

# SUSTAINABILITY

## SABELT SUSTAINABILITY OBJECTIVES

" We believe there is no alternative to this approach: playing our part, taking responsibility for our actions in building a wider economic and social system and creating a sustainable business for future generations.."

**Giorgio Marsiaj**

*Chairman and Chief Executive Officer*

Sabelt focus on 4 major goals: .....

Organizational structure and economic performance

Innovation and Quality

People and Territory

Environment

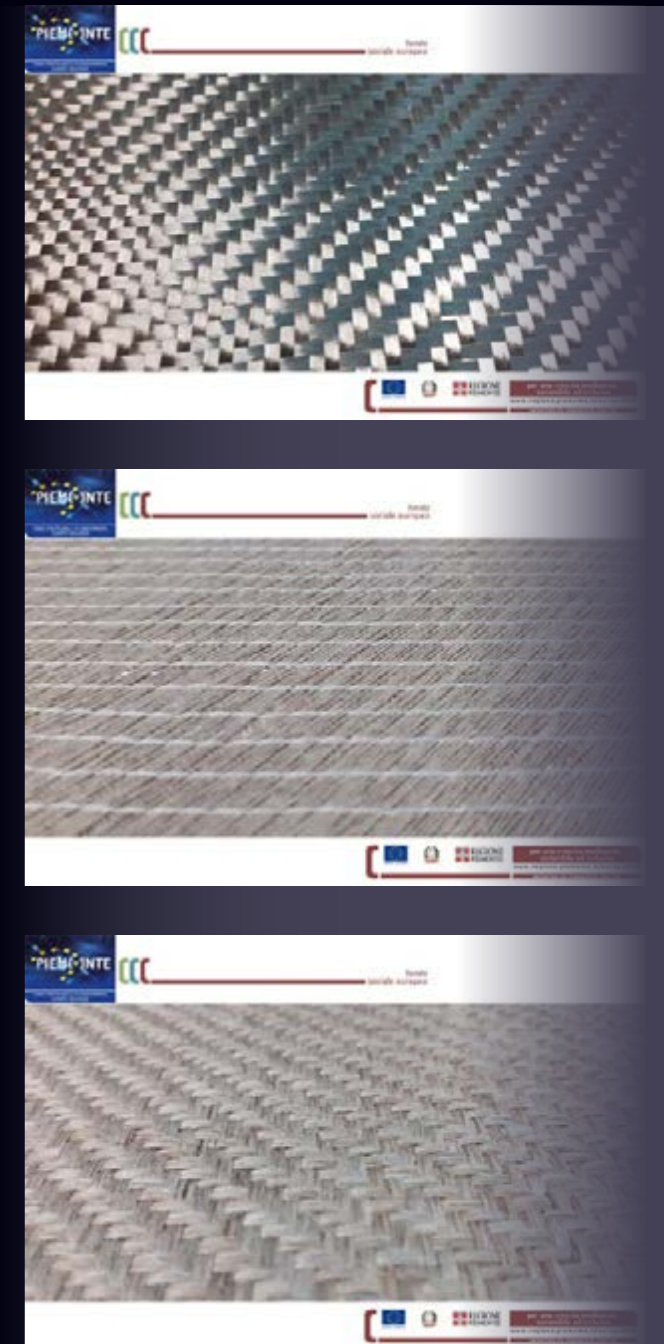

### • Carbogreen Project

Since 2019 Sabelt has been working in reducing the environmental impact of its production. The aim is to develop and produce a new line of seats made with innovative and "green" materials. Thanks to the Carbogreen project, financed within the "IR<sup>2</sup>" call issued by the Piedmont Region in Italy and supported by the European Fund for Regional Development, the company is evolving to become a low environmental impact manufacturer.

# SAFETY AND LABORATORY



The pursuit of safety has played a key role since the foundation of Sabelt. We have been the first to equip the laboratories of our plant with a dynamic test which simulates crashes and pre-homologates products for the strict automotive standards: an innovative system prescribed by ECE and FIA regulations. All tests are conducted with the specific intent to maintain a bigger margin to the minimum required, with outstanding performance levels built with style and design.

# PRODUCTION



All Sabelt products are designed and engineered exclusively by Sabelt in the operational headquarters in Turin, in collaboration with external design centers or in partnership with clients car makers.

# AUTOMOTIVE SEATING



From the world of motorsport, Sabelt has developed a range of premium sports seats for the world's top car manufacturers. It designs and manufactures safety belts and seats for vehicles with a strong sporting connotation, dedicated to an advanced and demanding driver, that is sports oriented and has a particular attention to quality. Its main partners are: Ferrari, McLaren, Alpine, Abarth, Alfa Romeo, Jaguar, Cupra, Maserati and Aston Martin.

# SPECIAL APPLICATIONS



Sabelt is able to develop and implement new technologies dedicated to various applications of safety seatbelts in niche markets, such as the military, aviation, aerospace, exceptional transport and many other fields where technical and customized products are required. Since 2010, Sabelt has been the supplier of Thales Alenia Space Italia for the restraint systems of the Cygnus Orbital-ATK module (belts and nets).



# HARNESSES



TECHNICAL PARTNER  
SCUDERIA FERRARI

FIA 8853-2016

GT / RALLY



WRC HARNESS



CCG632SRD



CCA622SRDLPM



CCA622SRDN1



CCA622SRUN1



CCA633SRUN



CCS632SRDN



CCS622SRUN



CCS633SRUN

FORMULA



F1 HARNESS



CCG832FSR



CCG622FSR



CCA622FRUN1



CCS622FRUN



CCS622FRUN1

SFI 16.1



CCS622SNUSFI



CCS533SNULLSFI

FIA 8854/98

GT / RALLY



CCA433SRDN



CCS433SRDN



CCS433SRUN

RACING NET

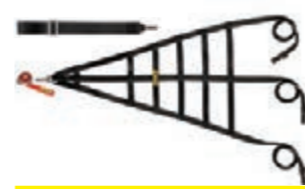

CFRN2008 NEW



CFRN2002



CFRN2003

ECE 16

CLUBMAN



CFCC4046 (no ECE)



CFCC904001NP\_A



CFCC904070NP\_B



CFCC904059NP\_B



CFCC904005N\_B



CFCC904002N\_A

WINDOW NET



Z280988



Z280985

## BUCKLES

**B1**

Tongues entry designed to simplify the driver fastening. Machined from solid aluminium.

**B5**

Tongues entry designed to simplify the driver fastening. Quick release with spring ejectors. 255 g

**B2**

With integrated crotch belt "T" type attachment. Aluminium. Patented buckle. 219 g

**B6**

Developed with Formula 1 Teams. Superlight buckle in machined from solid aluminium.

**B3**

For "Formula" safety belt developed in Formula 1. Aluminium. Protection for the lever. 192 g

**B4**

Buckle for 4 points safety belt. Aluminium. 184 g

**B7**

Developed for Endurance applications. 2019 and 2021 24h Le Mans winner. 266 g

**B8**

Latch buckle with leather pad and adjuster. 514 g

## ADJUSTERS

**A9**

2" Quick release adjuster machined from solid aluminium. Developed in Formula1. 54 g

**A10**

2" Quick release adjuster machined from solid aluminium. Developed for double shoulder belt. 74 g

**A1**

Quick release adjuster for 3" webbing. Forged and anodized aluminium. 2021 24h Le Mans winner. 95 g

**A2**

Quick release adjuster for 2" webbing. Forged and anodized aluminium. 70 g

**A13**

Aluminium quick adjuster 2" with webbing guide. 2019 24h Le Mans winner. 78 g

**A16**

Lap strap tongue with integrated adjuster for 2" width webbing. Steel. 2021 24h Le Mans winner. 113 g

**A3**

Adjuster integrated to the buckle tongue designed for 2" webbing. Developed for GT/Endurance cars. Steel-aluminium. 2019 24h Le Mans winner. 123 g

**A4**

Adjuster for 2" webbing. Steel-aluminium. 113 g

**NEW****A5**

"America" adjuster for 3" webbing. Steel. 147 g

**A6**

"America" adjuster for 2" webbing. Steel. 94 g

**A14**

Ergal "Tribar" adjuster for 2" webbing. Steel. 46 g

**A7**

"Tribar" adjuster for 3" webbing. Steel. 110 g

**A8**

"Tribar" adjuster for 2" webbing. Steel. 80 g

**A12**

"Bufflug" steel adjuster. 63 g

**A11**

Steel "Stop" adjuster for 2" webbing. 24 g

**A15**

Ergal "Tribar" adjuster for 3" webbing. Steel. 64 g

## FIXINGS

**F1**

Carabiner. Inox Steel. 24 g

**F2A**

Snap hook in combination with A7 or A8. Steel. 77 g

**F2B**

Sewn snap hook. Steel. 77 g

**F3A**

Fixing plate in combination with A7 or A8. Steel. 63 g

**F3B**

Sewn fixing plate. Steel. 63 g

**F4**

Sewn "P" type steel fixing plate. 47 g

**F5**

"Wrap around" fixing in combination with A7 or A8.

**F6**

"Sewn loop" fixing.

**F7**

Titanium double fixing plate for 2" webbing. For M8 screw. 38 g

**F8**

Small Sewn fixing plate. 45 g

**F9**

Small fixing plate. 44 g

**F10**

Double hole fixing plate. 38 g

**F11**

Sewn double hole fixing plate. 38 g

**F12**

X2 double hole fixing plate. 76 g

## TONGUES

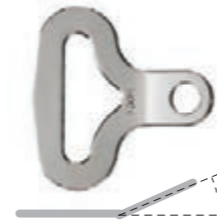
**T1**

Lap belt tongue with ergonomic bend. Steel. 32 g

**T2**

Shoulder belt tongue for 3" webbing. Steel. 30 g

**T3**

Shoulder belt tongue for 2" webbing. Steel. 23 g

**T4**

Titanium mini-tongue for CCG622FSR, CCG832FSR harnesses. 7 g

**T5**

Titanium tongue for E1 harnesses. 9 g

**T6**

Lap belt tongue with ergonomic bend. Titanium. 18 g

**T7**

Steel shoulder belt tongue +5 mm. 38 g

**T8**

Lap strap link. 86 g

**T9**

Left shoulder strap link. 69 g

**T10**

Right shoulder strap link. 69 g

**T11**

Crotch strap link. 57 g

## OPTIONALS

**02**

Logo printed directly on the webbing in high grip material for FHR.

**04**

Closure velcro for adjustable straps.

**05**

Ergonomic handle.

**06**

Intercom or Drink System cord.

**07**

Velcro on upper shoulder belt.

**08**

Vintage logo

# CCG632SRD

## STANDARD FEATURES

GT/RALLY				GOLD	FIA 8853-2016		
STANDARD MEASURES (mm)				STANDARD COLOURS/CODES			
A	B	C	D				
430	790	620	330	CCG632SRD	CCG632SND	CCG632SBD	

## CONFIGURATIONS ON DEMAND



# CCA622SRDLPM

## STANDARD FEATURES

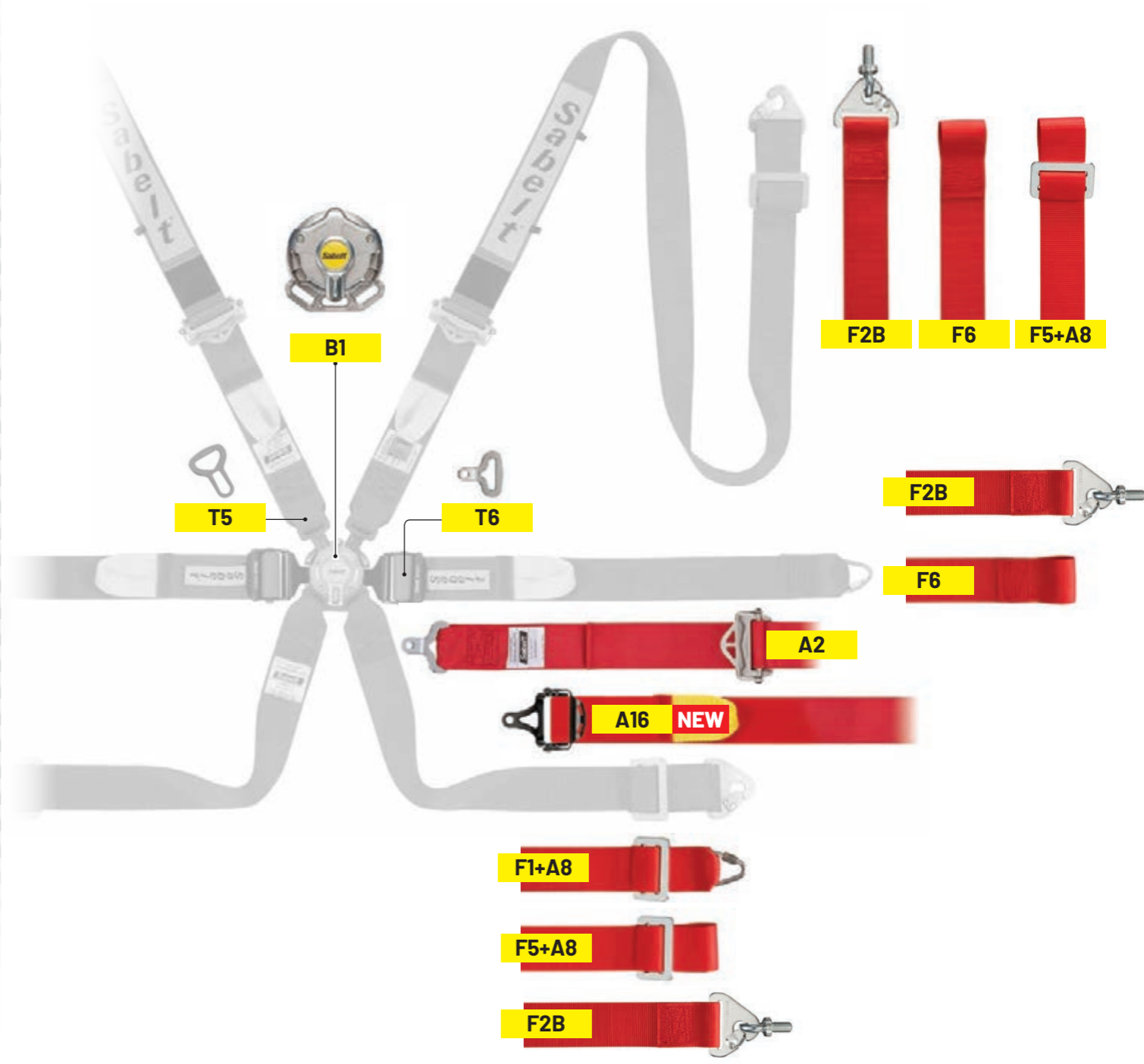
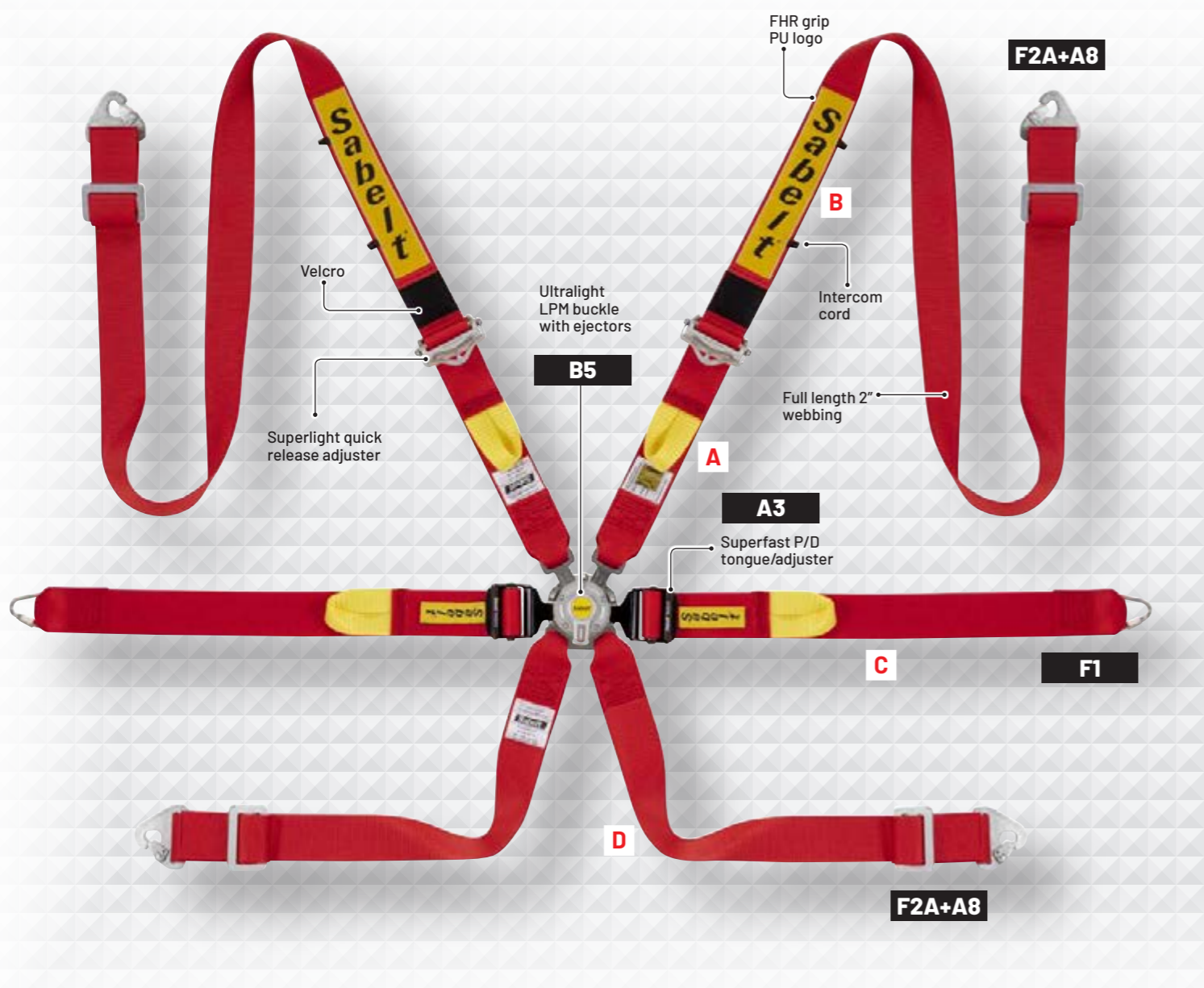
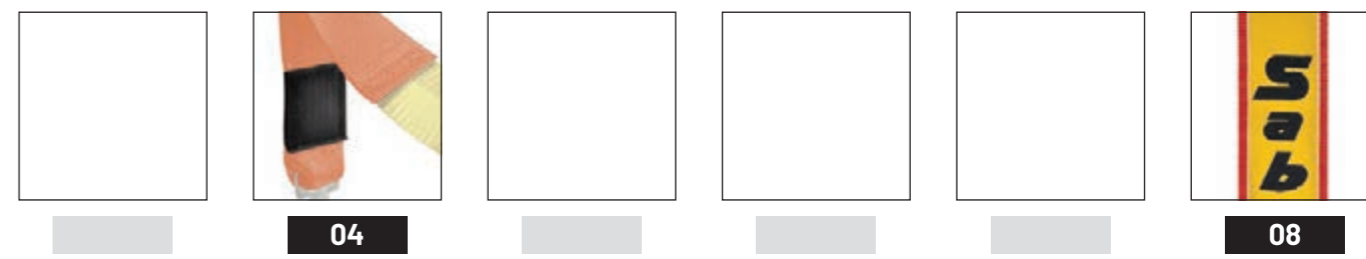

GT/RALLY				SILVER	FIA 8853-2016	
STANDARD MEASURES (mm)				STANDARD COLOURS/CODES		
A	B	C	D			
380	1700	680	850	CCA622SRDLPM	CCA622SNDLPM	CCA622SBDLPM

## CONFIGURATIONS ON DEMAND



# CCA622SRDN1

## STANDARD FEATURES

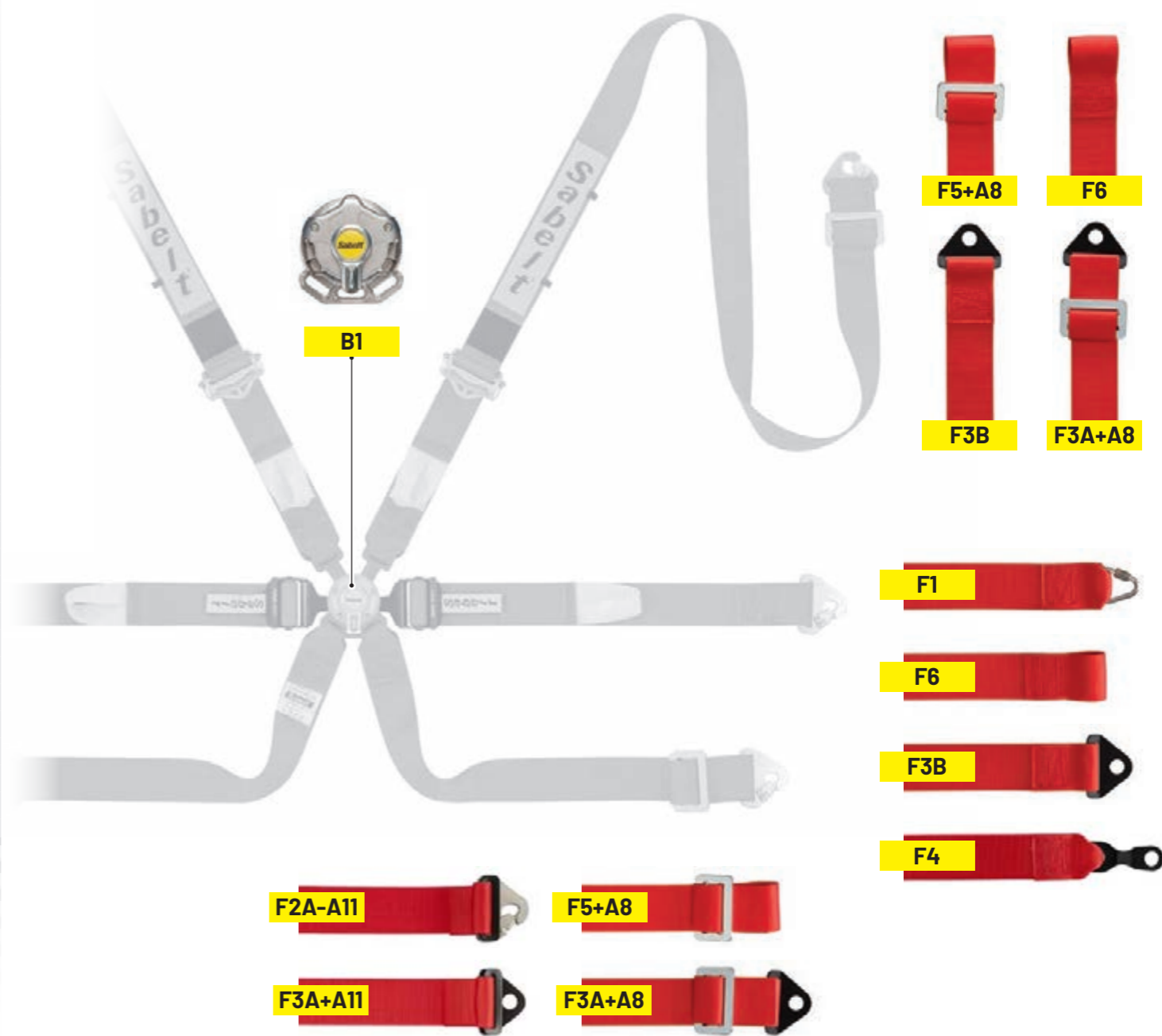
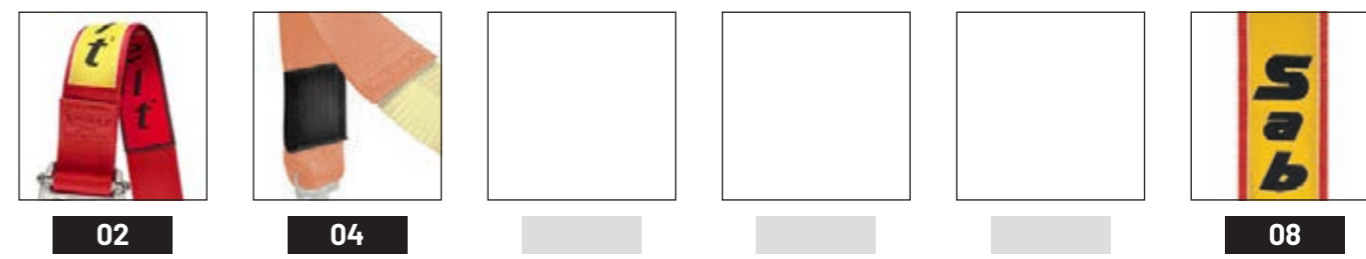

GT/RALLY				SILVER	FIA 8853-2016		
STANDARD MEASURES (mm)				STANDARD COLOURS/CODES			
A	B	C	D				
380	1700	680	850	CCA622SRDN1	CCA622SNDN1	CCA622SBDN1	

## CONFIGURATIONS ON DEMAND



# CCA622SRUN1

## STANDARD FEATURES

GT/RALLY				SILVER	FIA 8853-2016	
STANDARD MEASURES (mm)				STANDARD COLOURS/CODES		
A	B	C	D			
380	1700	560+120	850	CCA622SRUN1	CCA622SNUN1	CCA622SBUN1

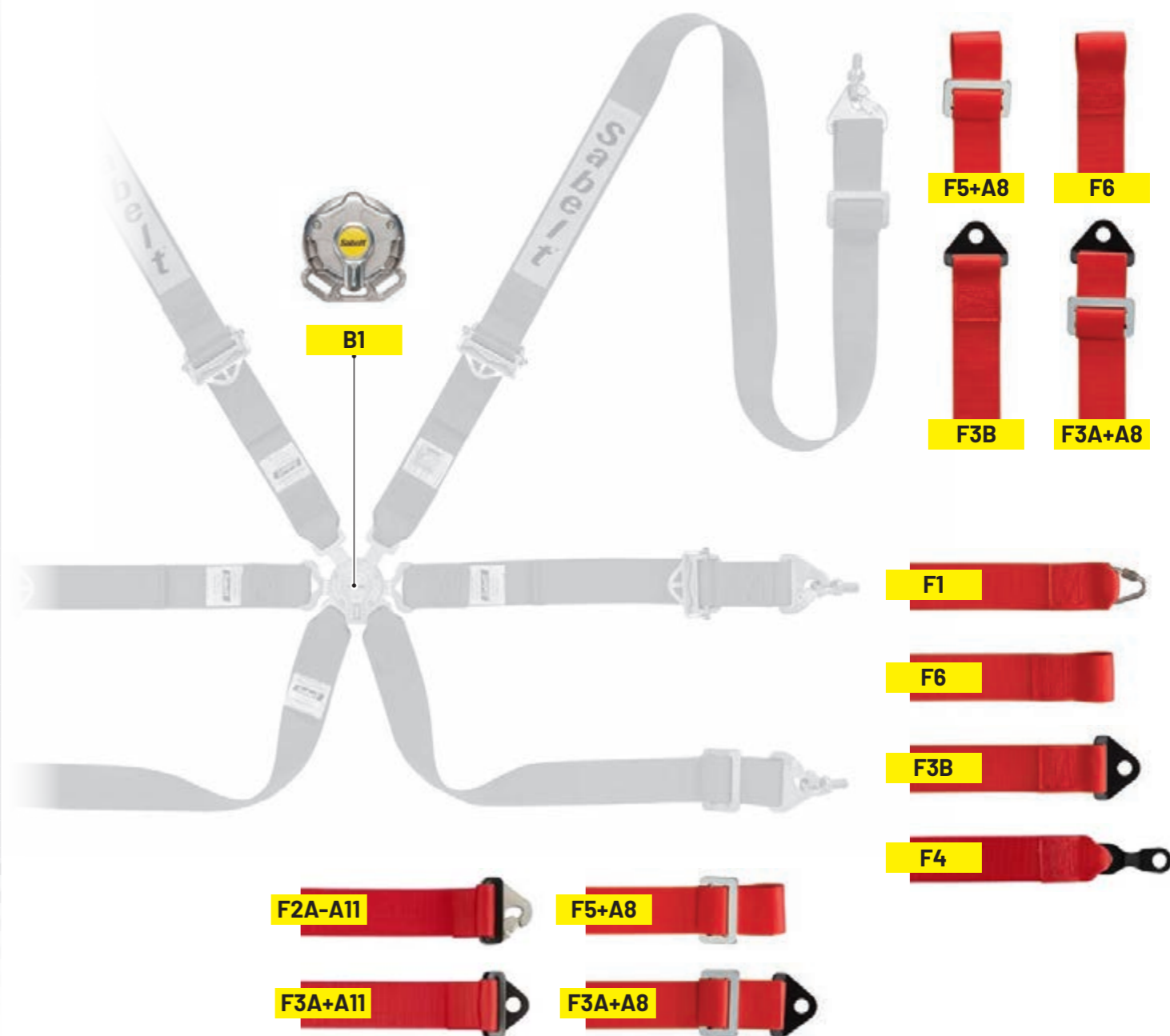

## CONFIGURATIONS ON DEMAND





# CCA633SRUN

## STANDARD FEATURES

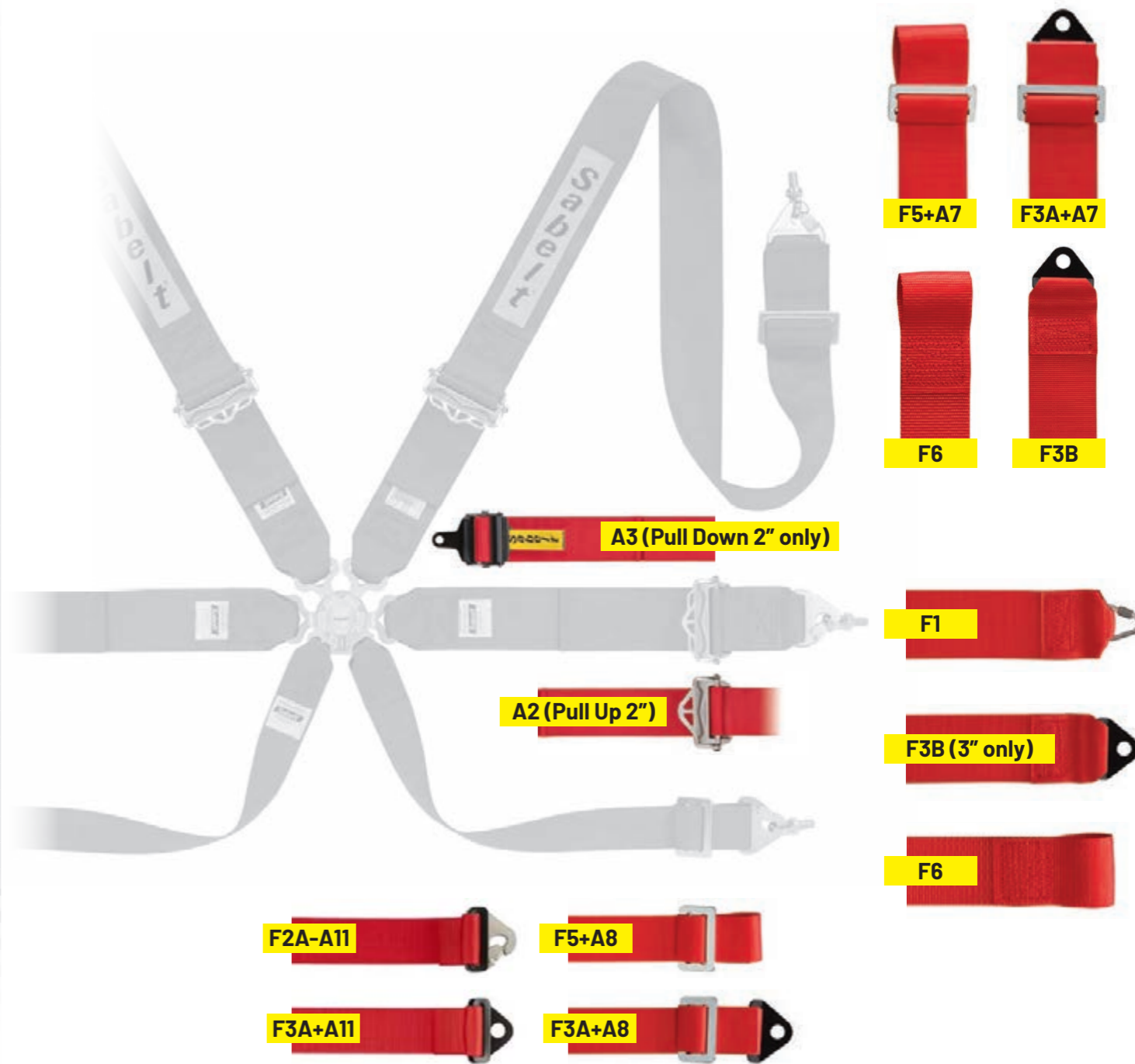

GT/RALLY				SILVER	FIA 8853-2016	
STANDARD MEASURES (mm)				STANDARD COLOURS/CODES		
A	B	C	D			
380	1700	560+120	850	CCA633SRUN	CCA633SNUN	CCA633SBUN

## CONFIGURATIONS ON DEMAND



# CCS632SRDN

## STANDARD FEATURES

GT/RALLY				STEEL	FIA 8853-2016		
STANDARD MEASURES (mm)				STANDARD COLOURS/CODES			
A	B	C	D				
380	1700	680	850	CCS632SRDN	CCS632SNDN	CCS632SBDN	





## CONFIGURATIONS ON DEMAND



# CCS622SRUN

## STANDARD FEATURES

GT/RALLY				STEEL	FIA 8853-2016	
STANDARD MEASURES (mm)				STANDARD COLOURS/CODES		
A	B	C	D			
380	1700	560+120	850	CCS622SRUN	CCS622SNUN	CCS622SBUN

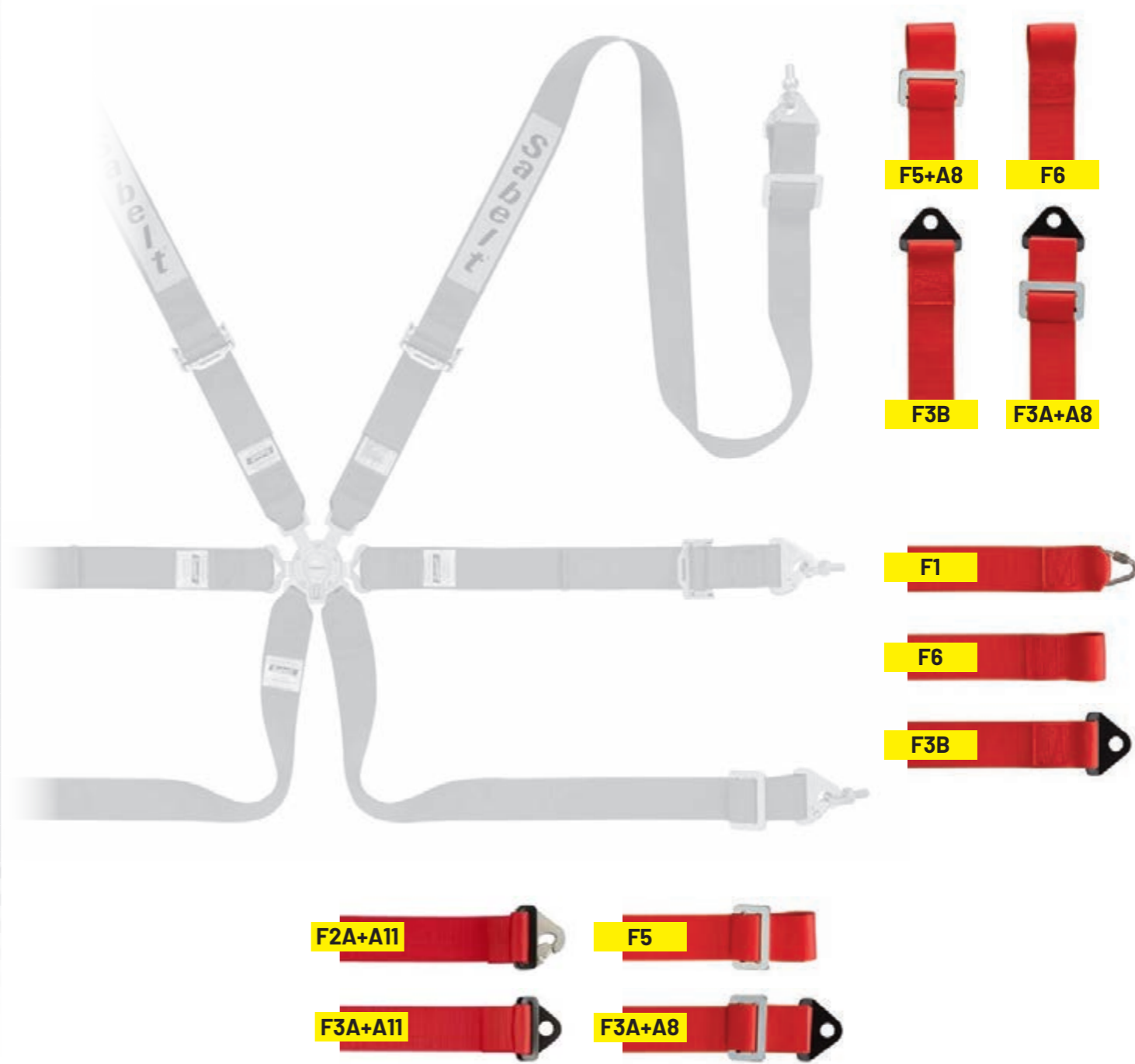
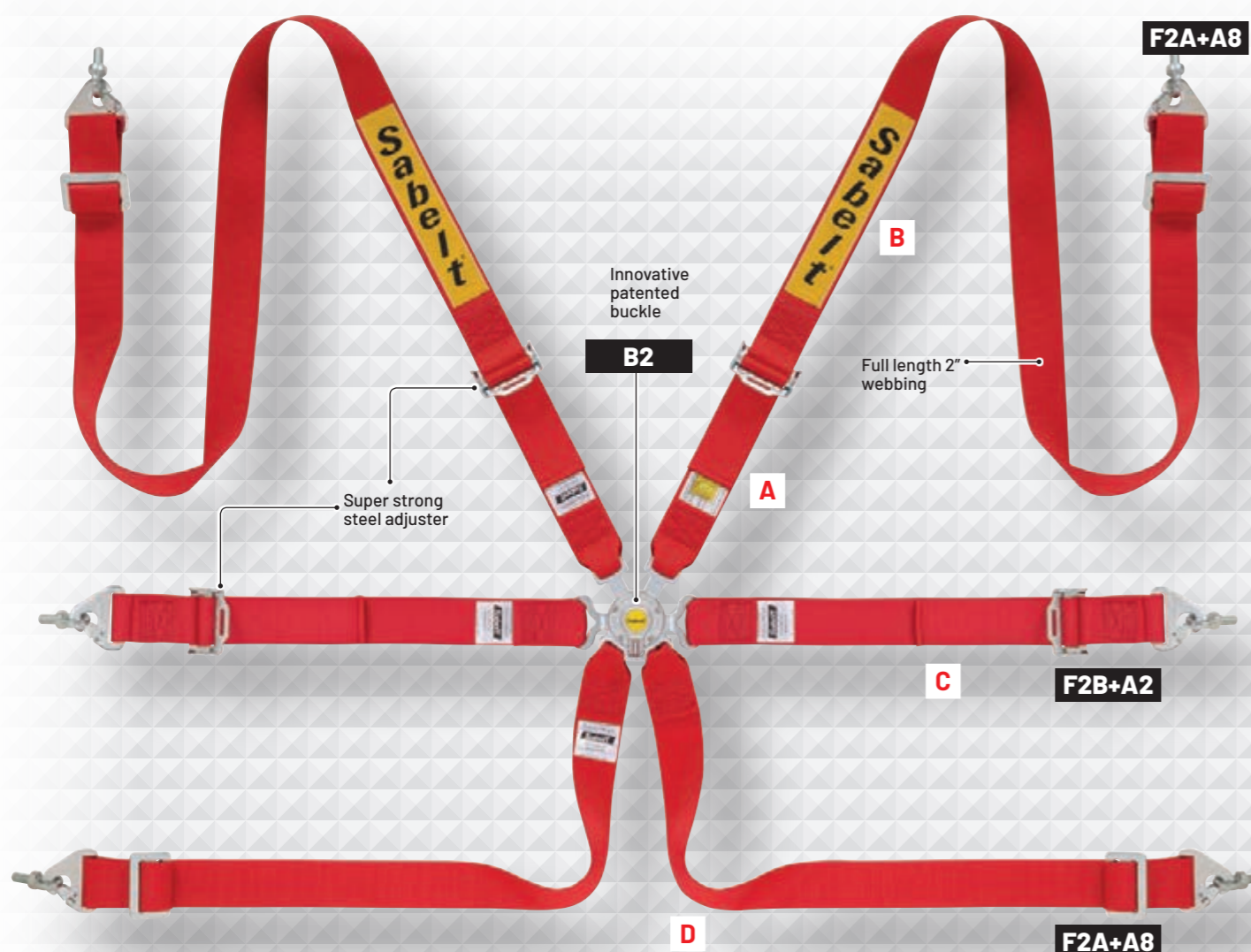
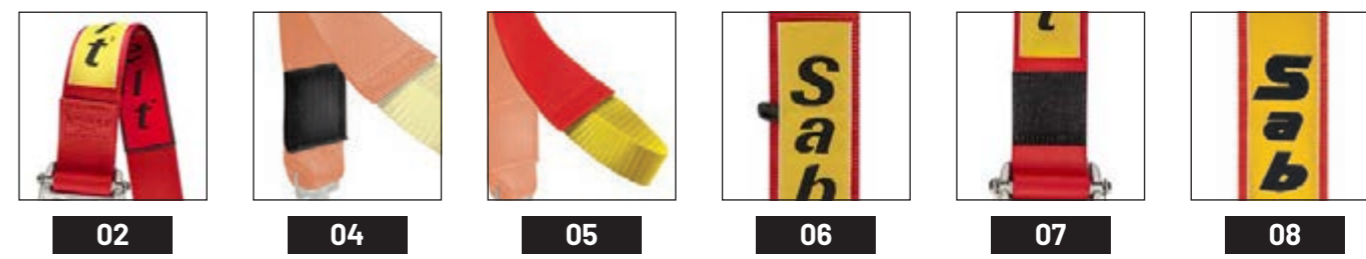

## CONFIGURATIONS ON DEMAND



MANUFACTURER: SABELT  
 MODEL: NEW SPEC SALOON  
 HOM. NO: SH.001.16-T-6  
 FIA STANDARD: 8853-2016

# CCS633SRUN

## STANDARD FEATURES

GT/RALLY				STEEL	FIA 8853-2016	
STANDARD MEASURES (mm)				STANDARD COLOURS/CODES		
A	B	C	D			
380	1700	560+120	850	CCS633SRUN	CCS633SNUN	CCS633SBUN

## CONFIGURATIONS ON DEMAND

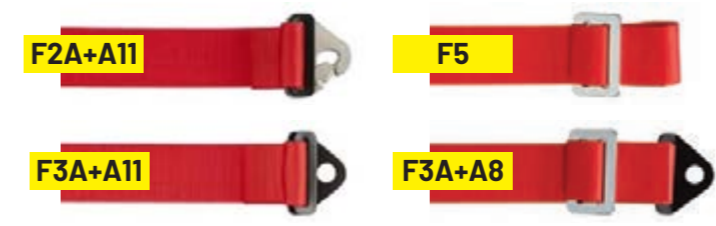
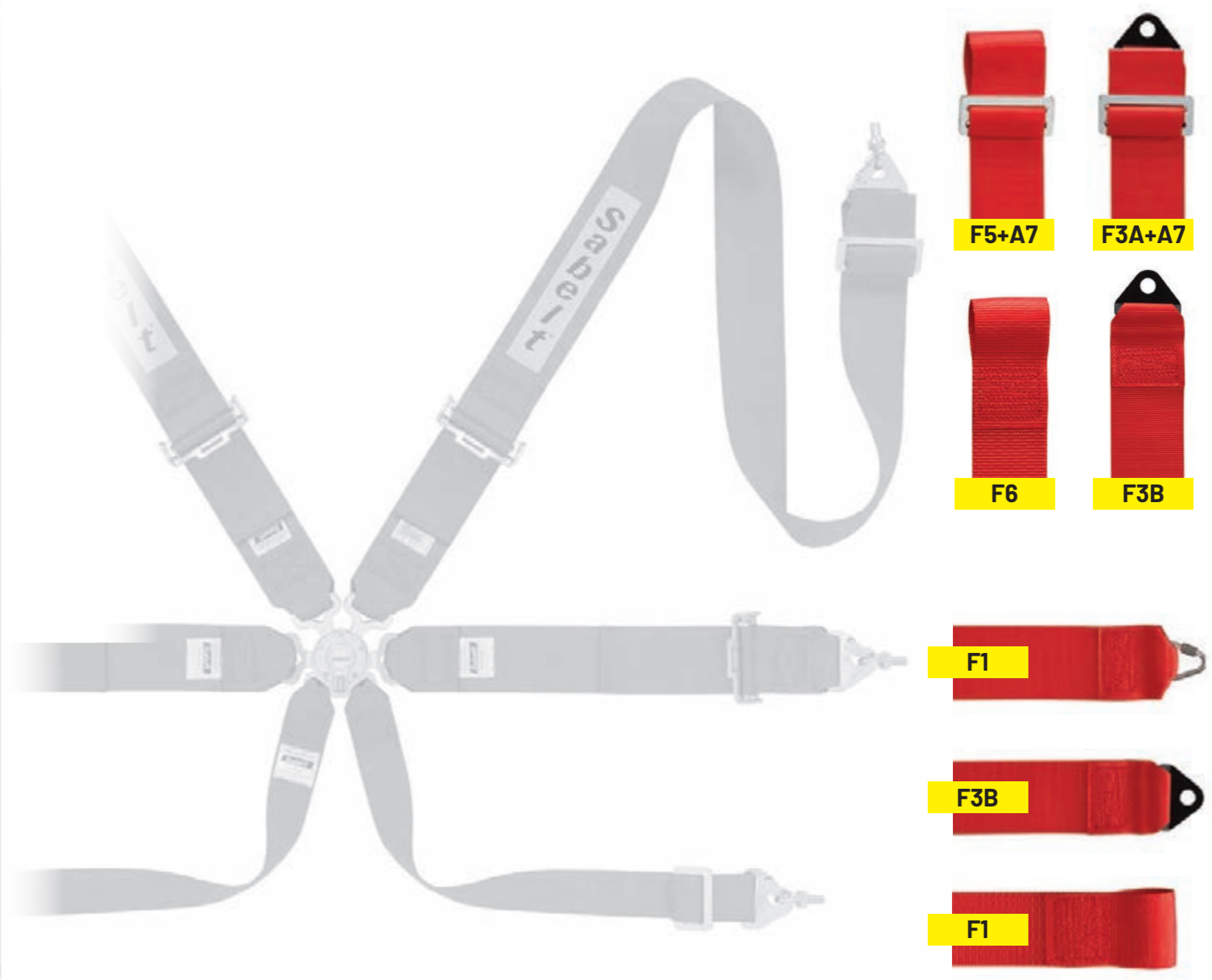
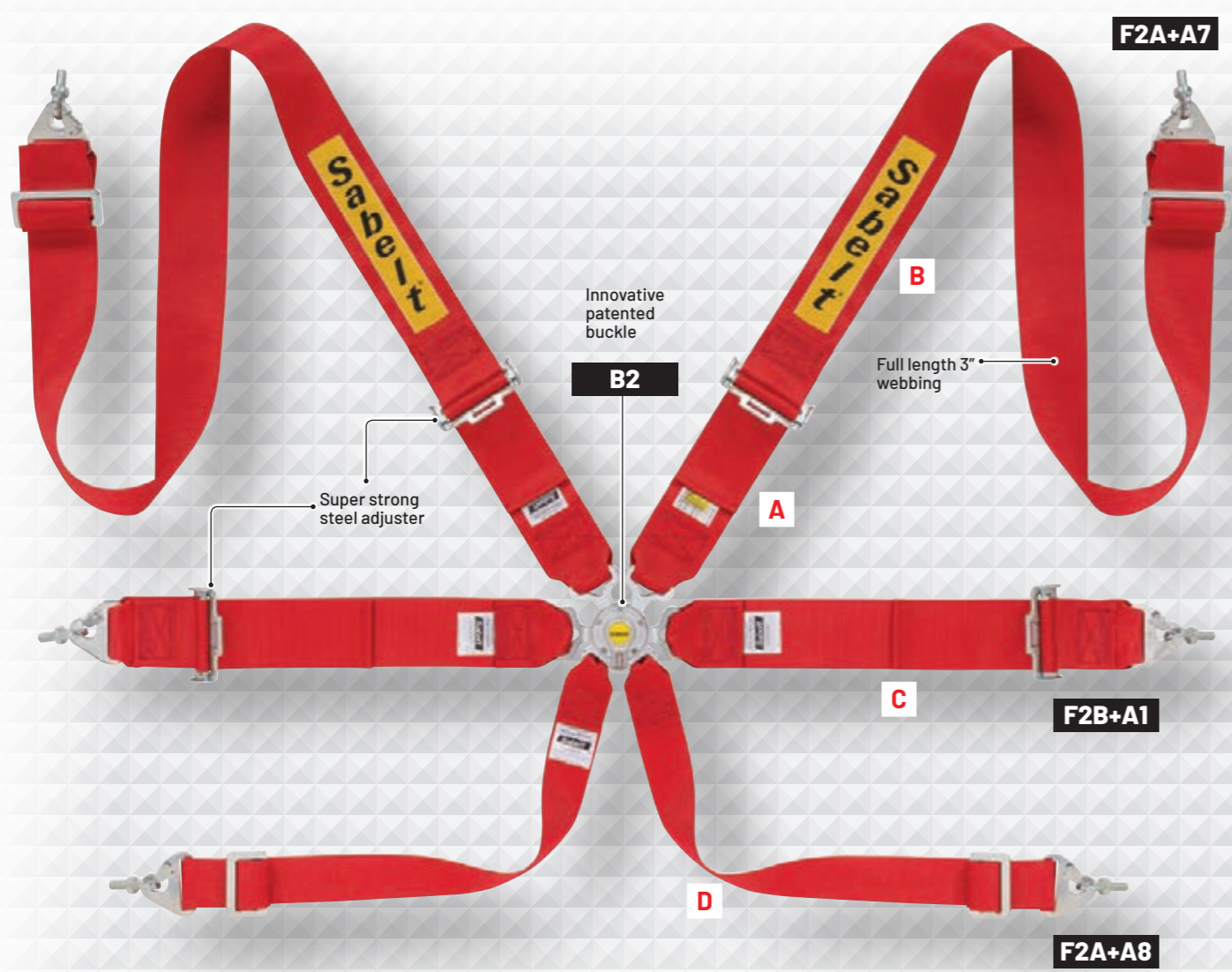
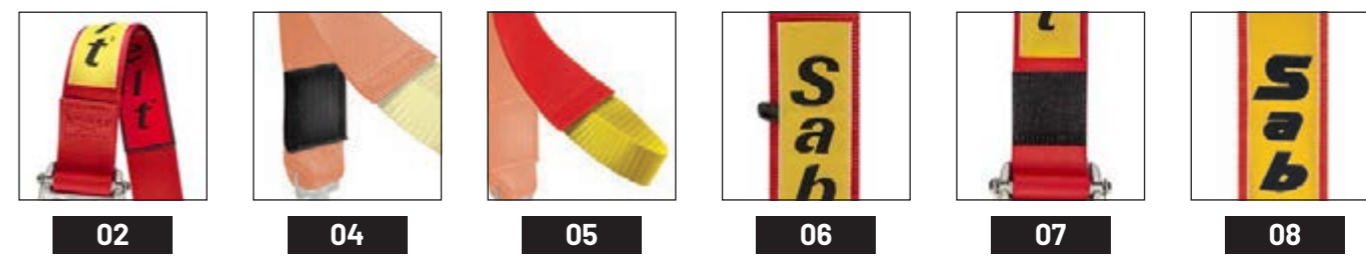

# CCG832FSR

## STANDARD FEATURES

FORMULA					GOLD	FIA 8853-2016	
STANDARD MEASURES (mm)					STANDARD COLOURS/CODES		
A	B2	B3	C	D			
360	495+105	430	975 FULL Length	960 FULL Length	CCG832FSR	CCG832FSN	

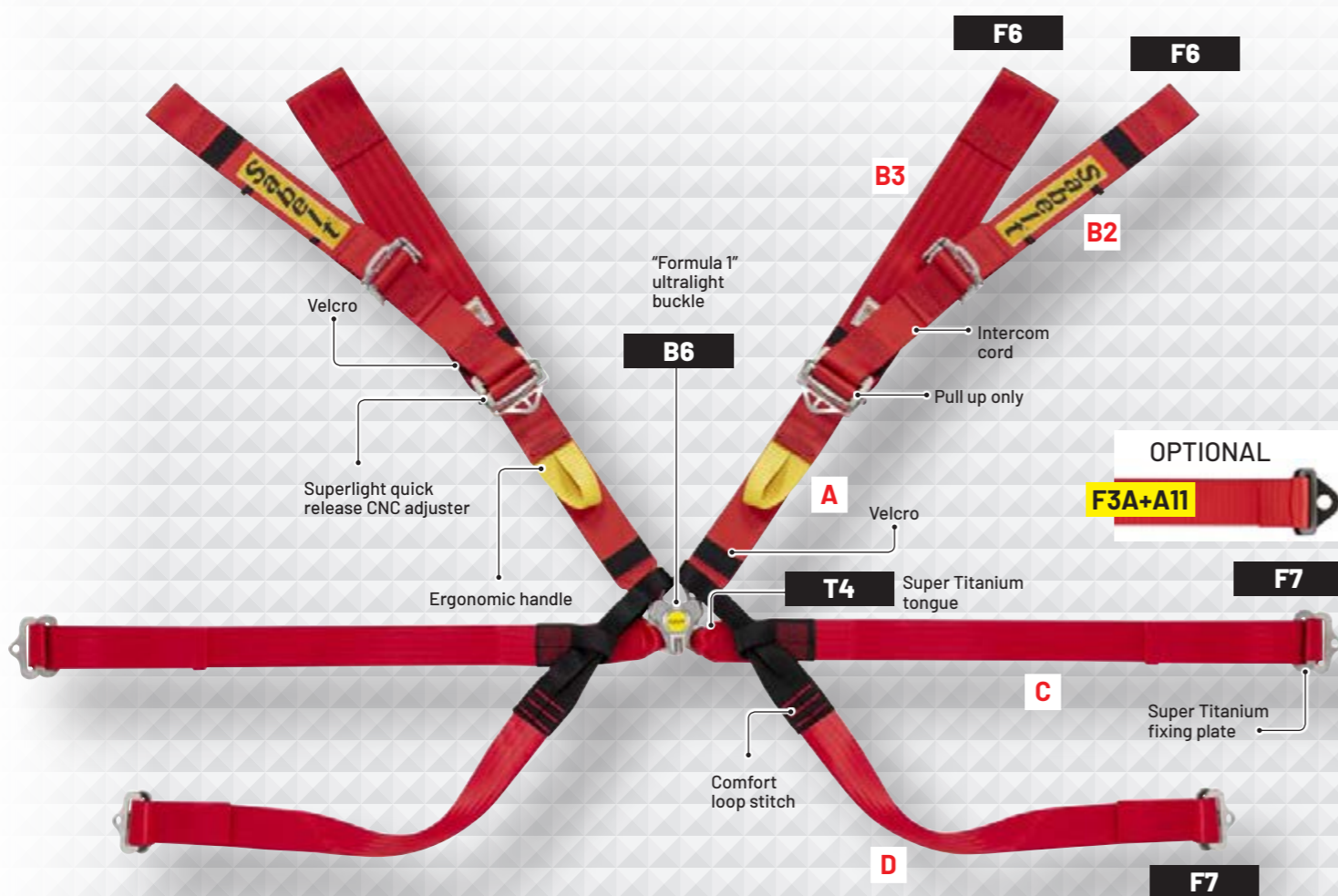

MANUFACTURER: SABELT  
 MODEL: NEW SPEC F4  
 HOM. NO: SH.061.19-T-8  
 FIA STANDARD: 8853-2016

# CCG622FSR

## STANDARD FEATURES

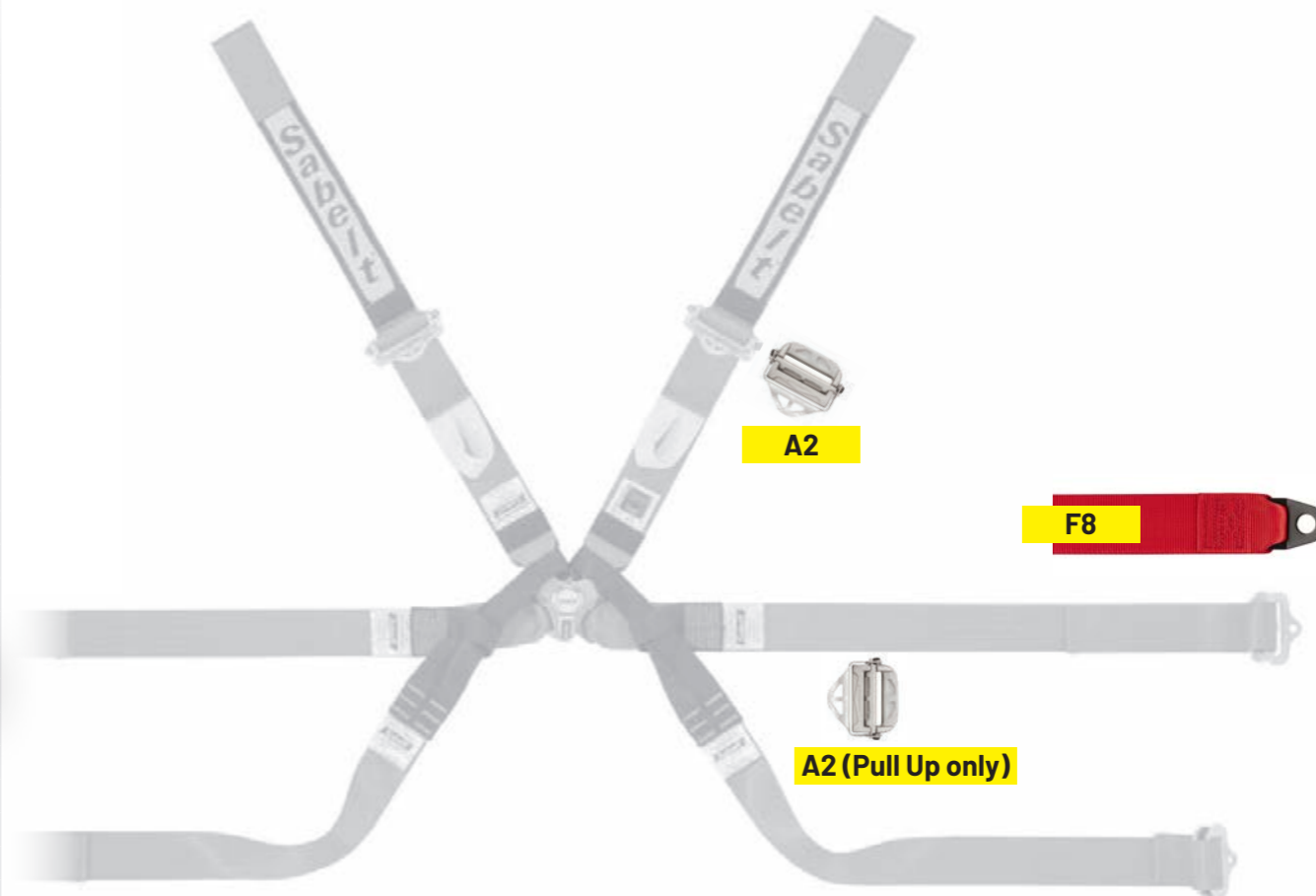
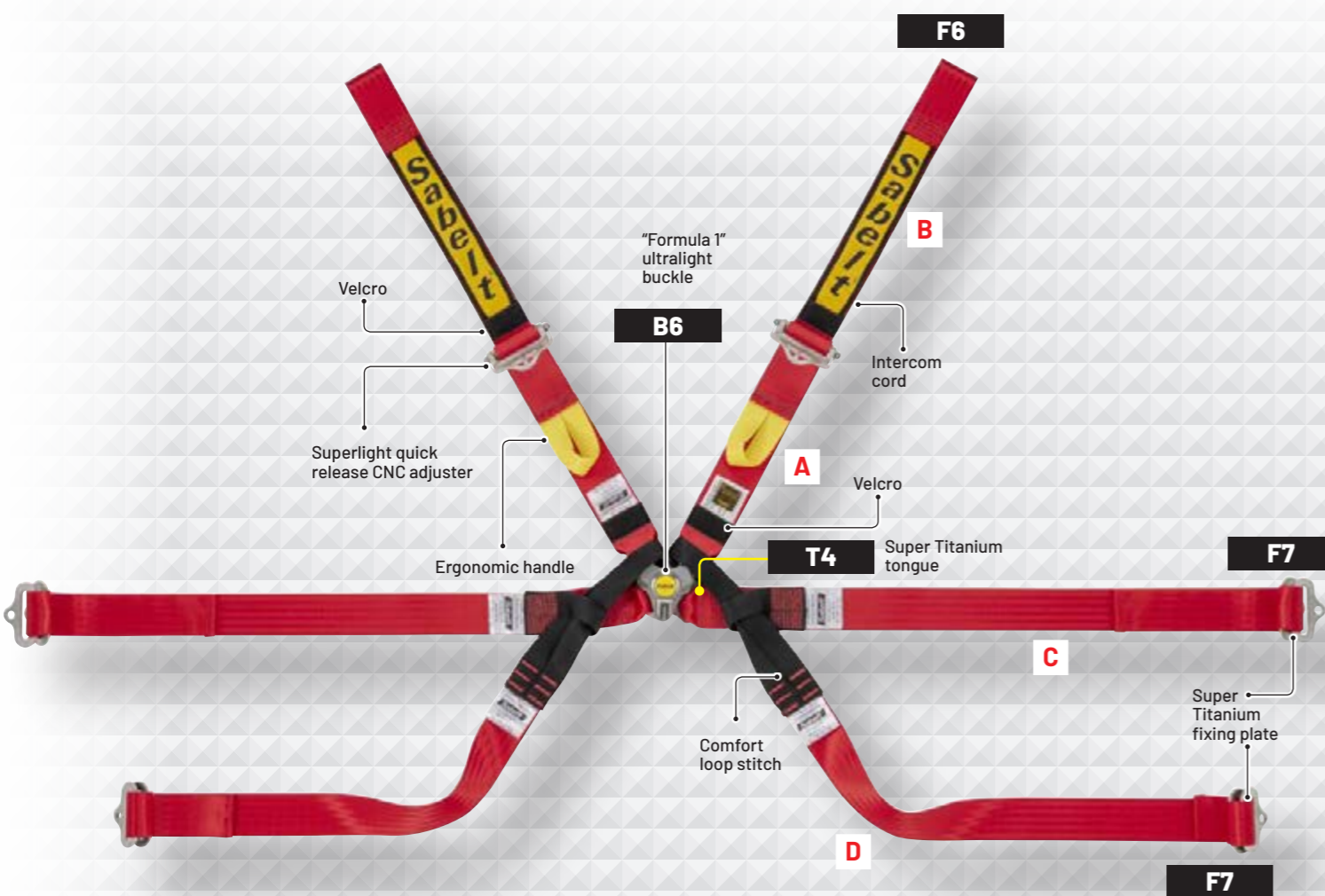
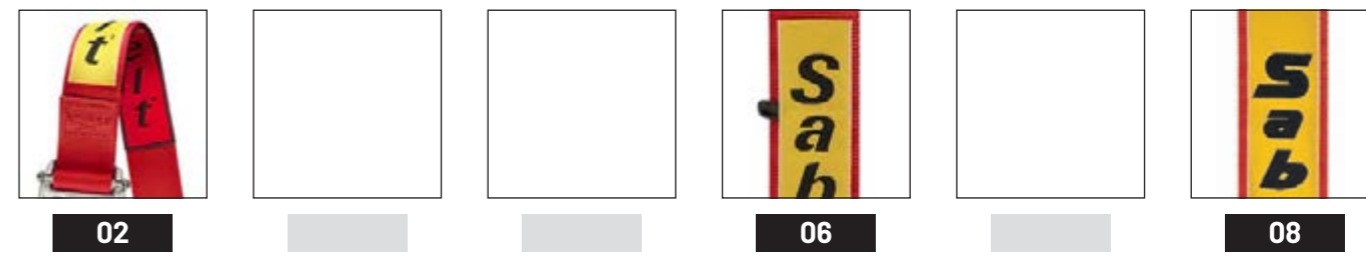

FORMULA				GOLD	FIA 8853-2016	
STANDARD MEASURES (mm)				STANDARD COLOURS/CODES		
A	B	C	D			
360	370	975 FULL Length	960 FULL Length	CCG622FSR	CCG622FSN	

## CONFIGURATIONS ON DEMAND



# CCA622FRUN1

## STANDARD FEATURES

FORMULA				SILVER	FIA 8853-2016		
STANDARD MEASURES (mm)				STANDARD COLOURS/CODES			
A	B	C	D				
440	700	530+120	1200	CCA622FRUN1	CCA622FNUN1	CCA622FBUN1	

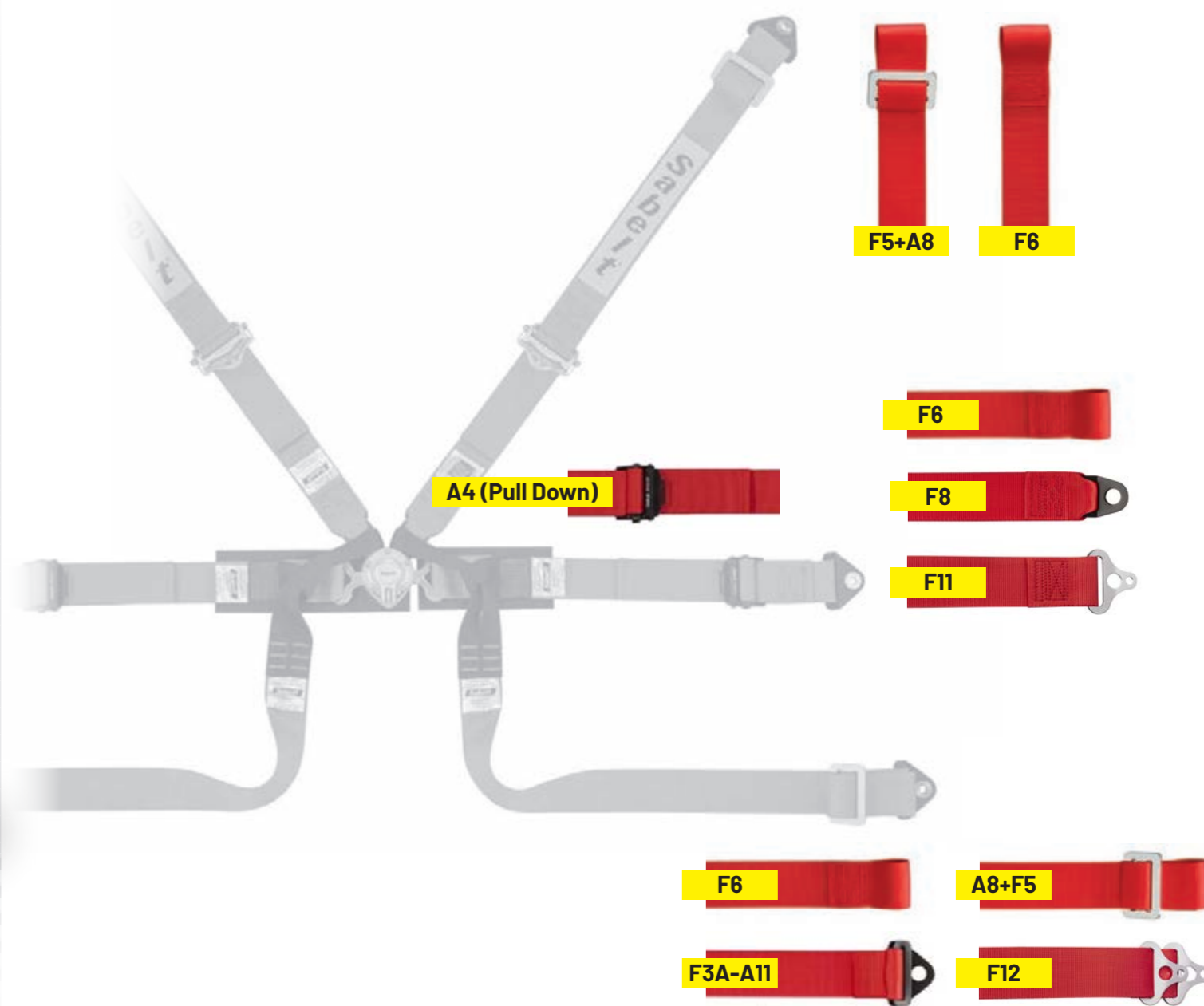
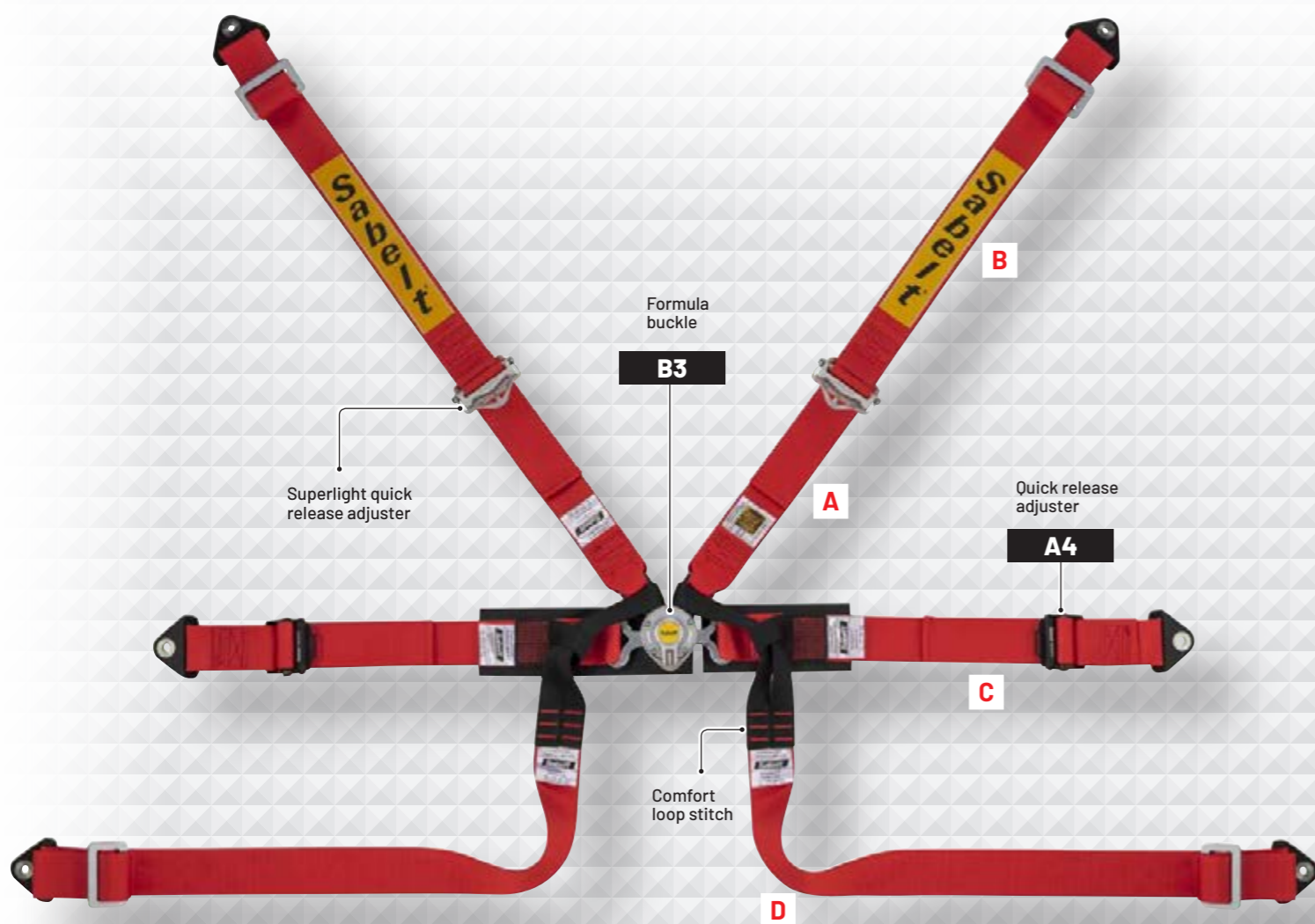

## CONFIGURATIONS ON DEMAND



MANUFACTURER: SABELT  
 MODEL: NEW SPEC F2  
 HOM. NO: SH.033.17-T-6  
 FIA STANDARD: 8853-2016

# CCS622FRUN

## STANDARD FEATURES

FORMULA				STEEL	FIA 8853-2016		
STANDARD MEASURES (mm)				STANDARD COLOURS/CODES			
A	B	C	D				
440	700	530+120	1200	CCS622FRUN	CCS622FNUN	CCS622FBUN	

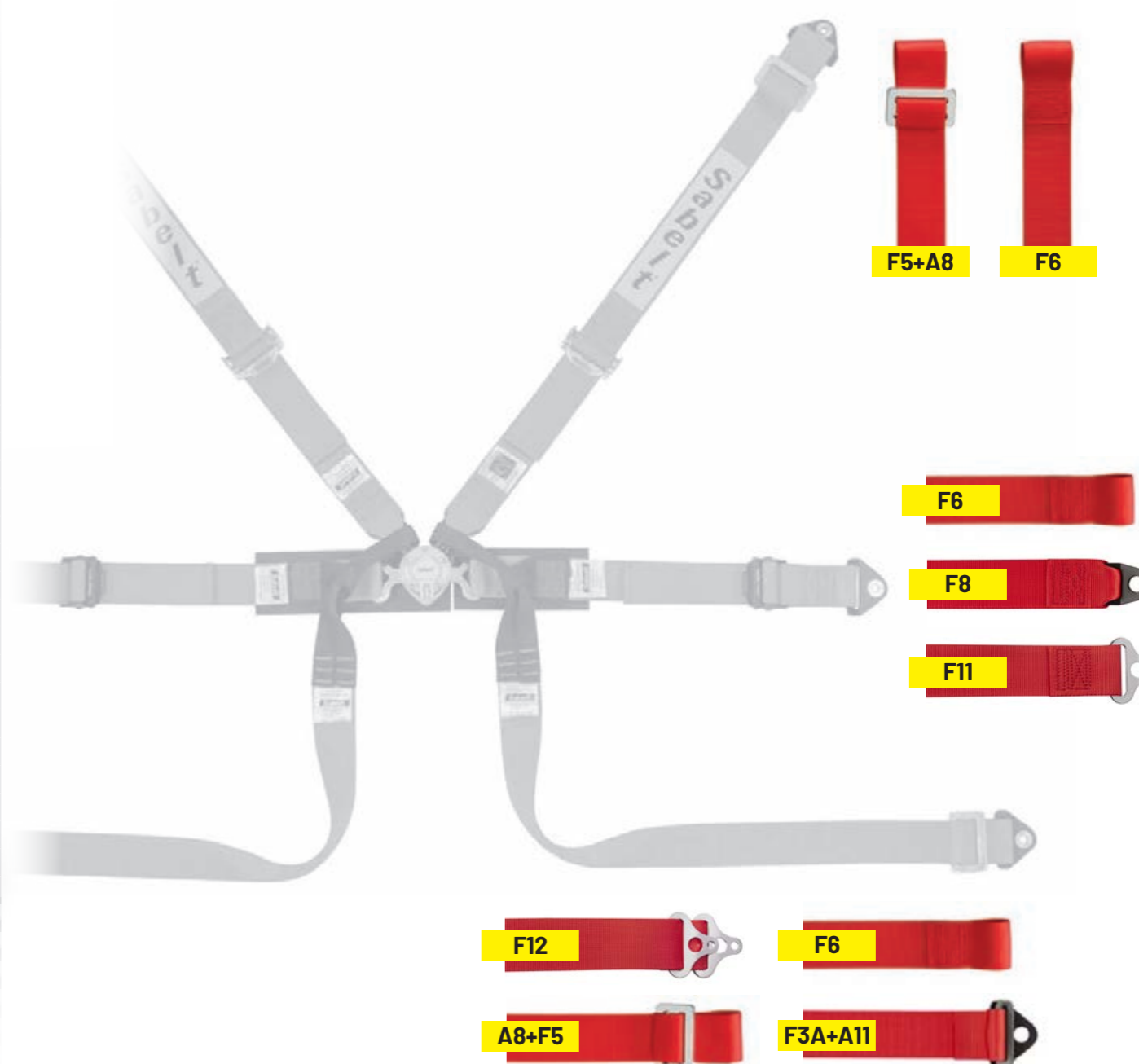
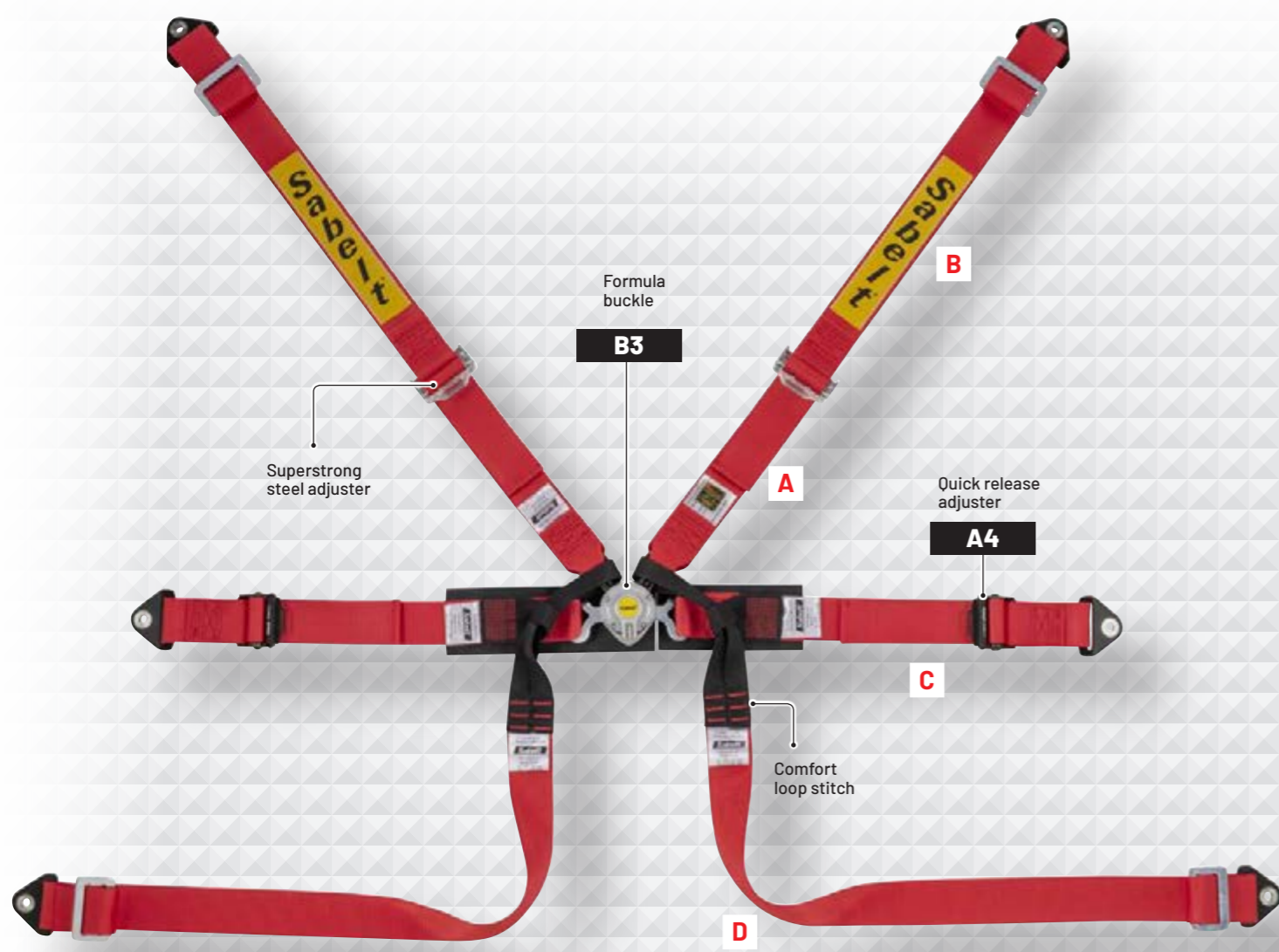

## CONFIGURATIONS ON DEMAND





# CCS622FRUN1

## STANDARD FEATURES

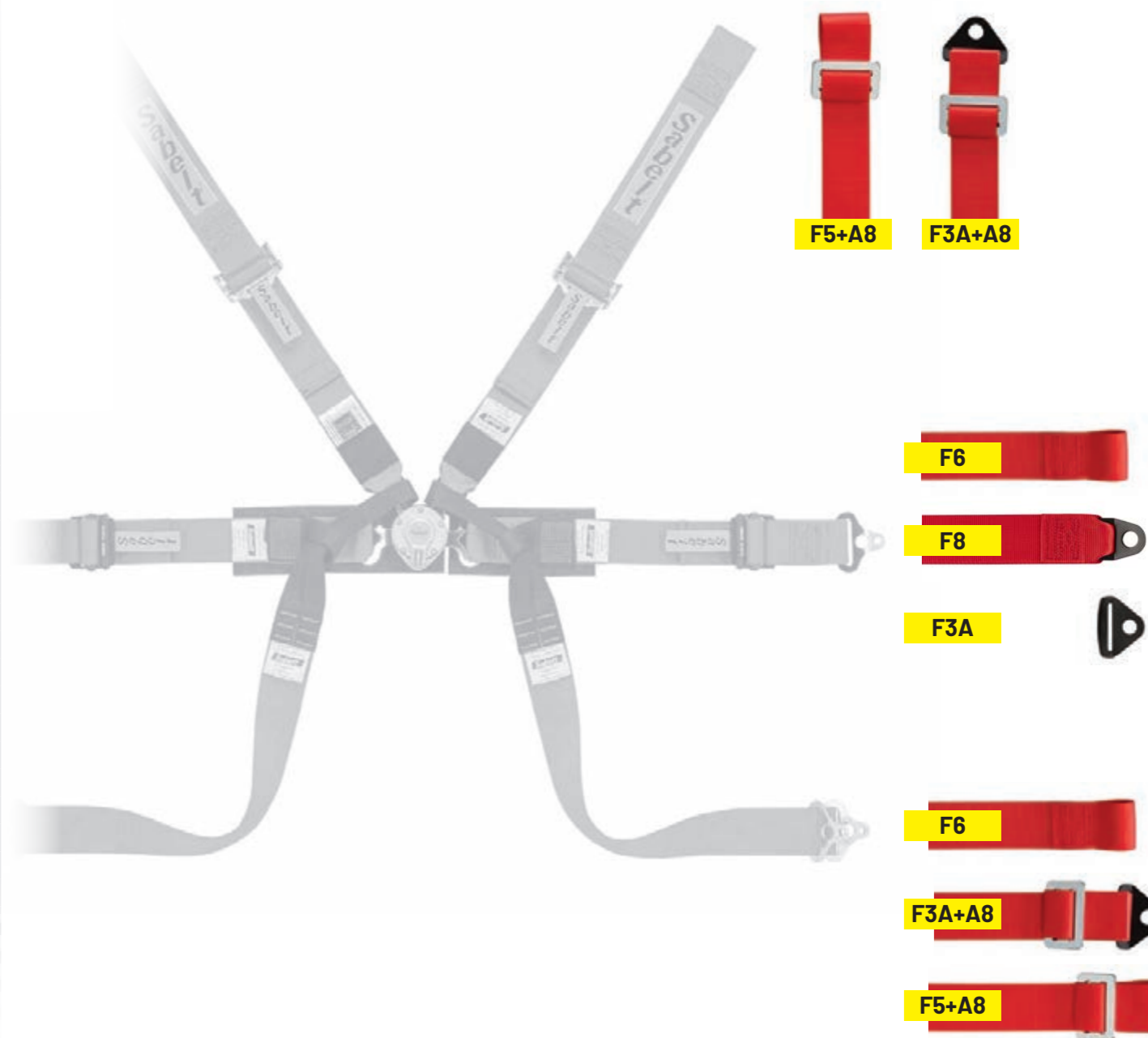
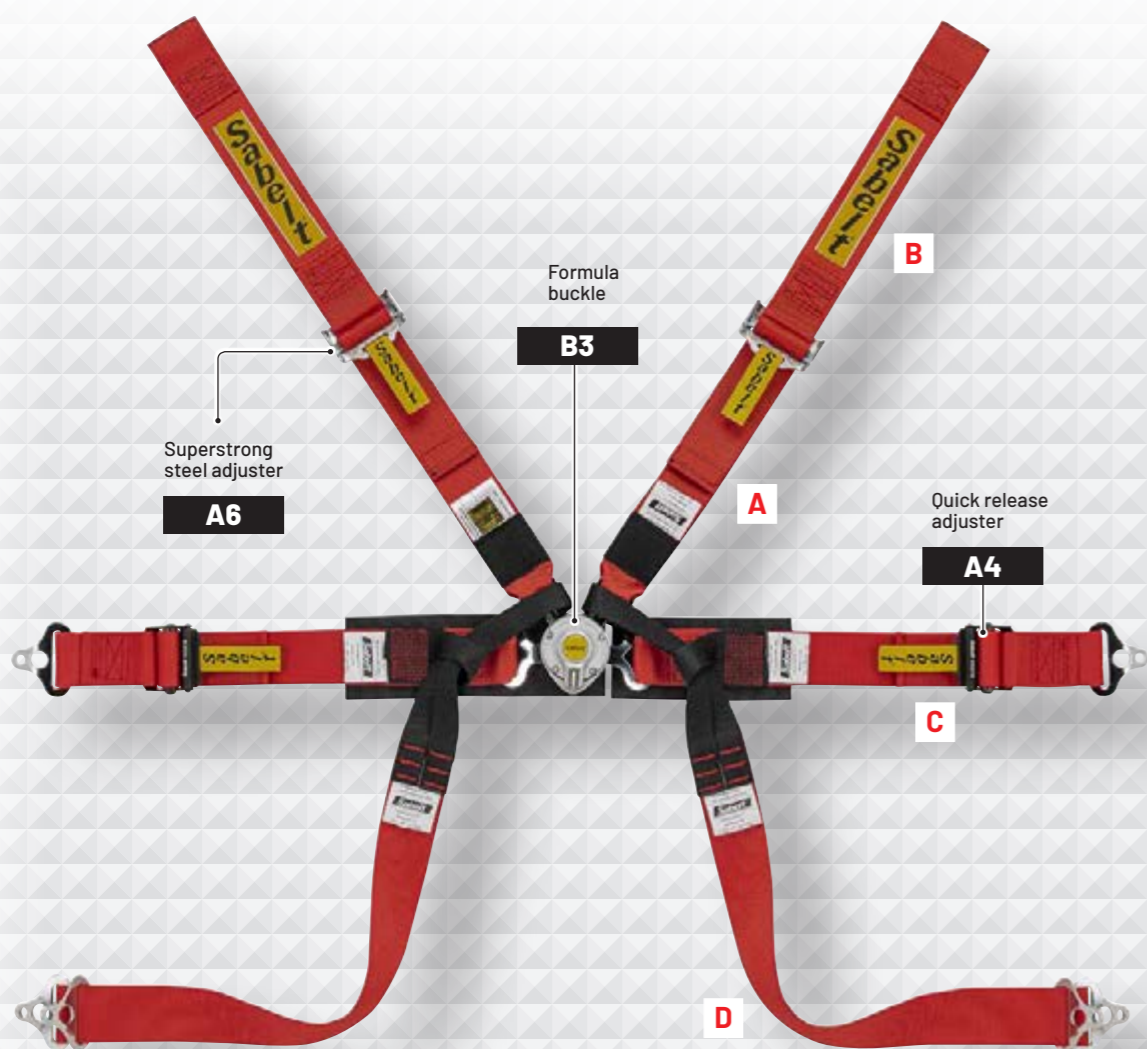
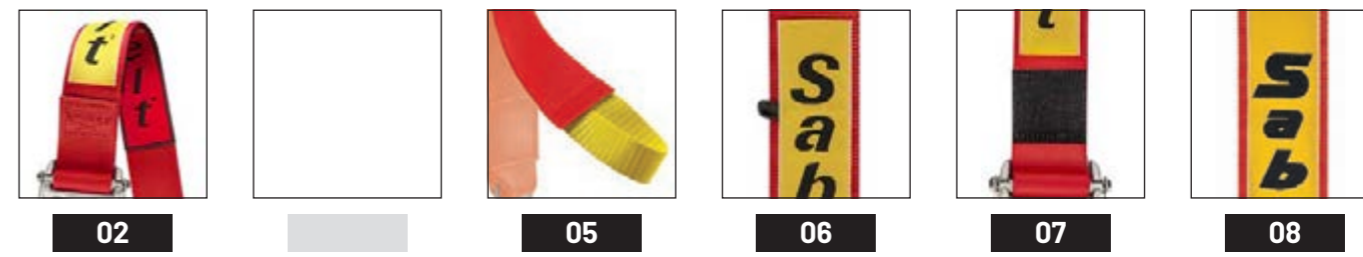

FORMULA				STEEL	FIA 8853-2016		
STANDARD MEASURES (mm)				STANDARD COLOURS/CODES			
A	B	C	D				
440	320	400+120	950	CCS622FRUN1	CCS622FNUN1	CCS622FBUN1	

## CONFIGURATIONS ON DEMAND



# CCA433SRDN

## STANDARD FEATURES

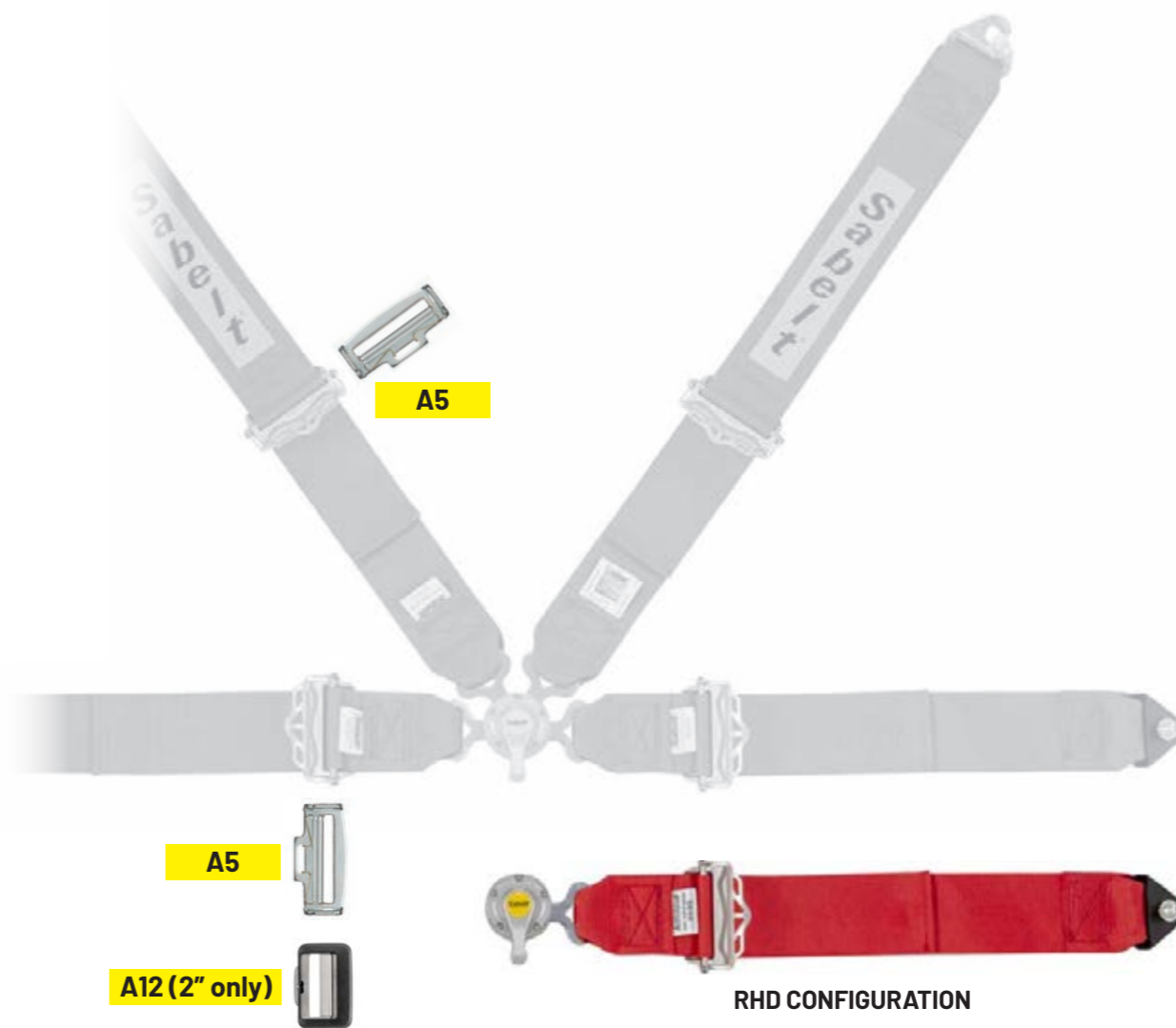
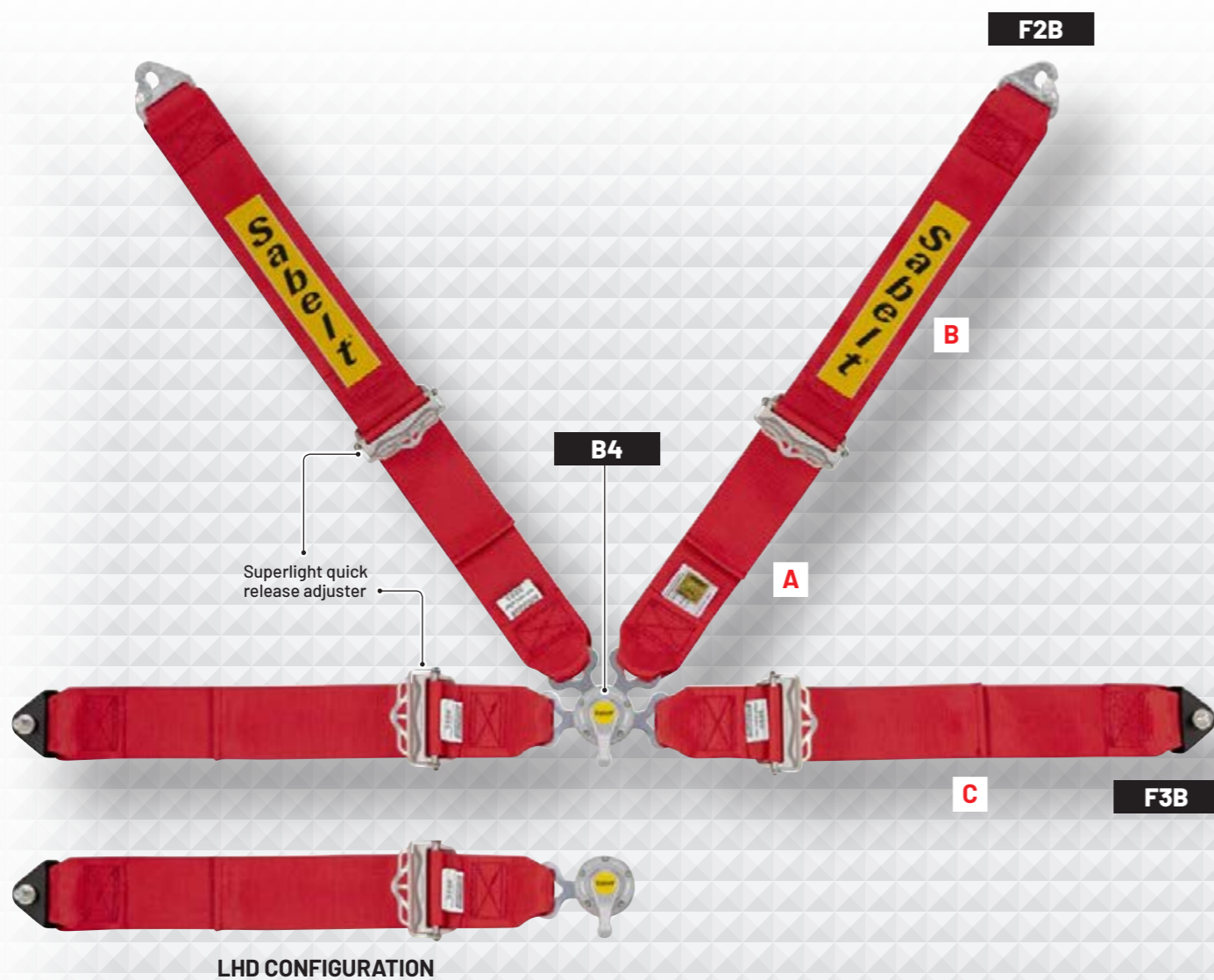

<b>SALOON - FOR KIT CAR "W"</b>				SILVER	FIA 8854/98	
STANDARD MEASURES (mm)				STANDARD COLOURS/CODES		
<b>A</b>	<b>B</b>	<b>C</b>				
480	450	130+610		CCA433SRDN	CCA433SNDN	CCA433SBDN

## CONFIGURATIONS ON DEMAND



# CCS433SRDN

## STANDARD FEATURES

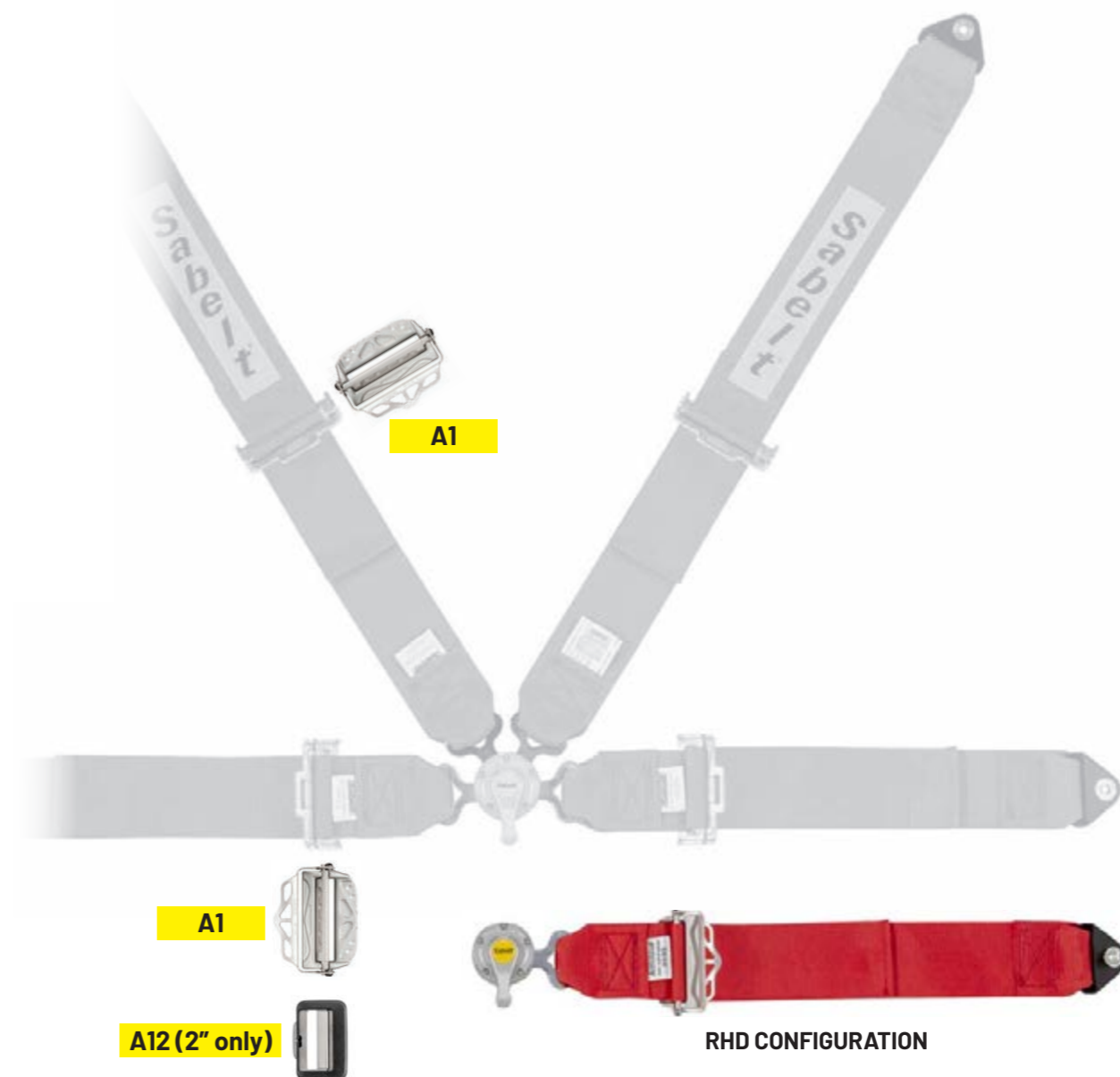
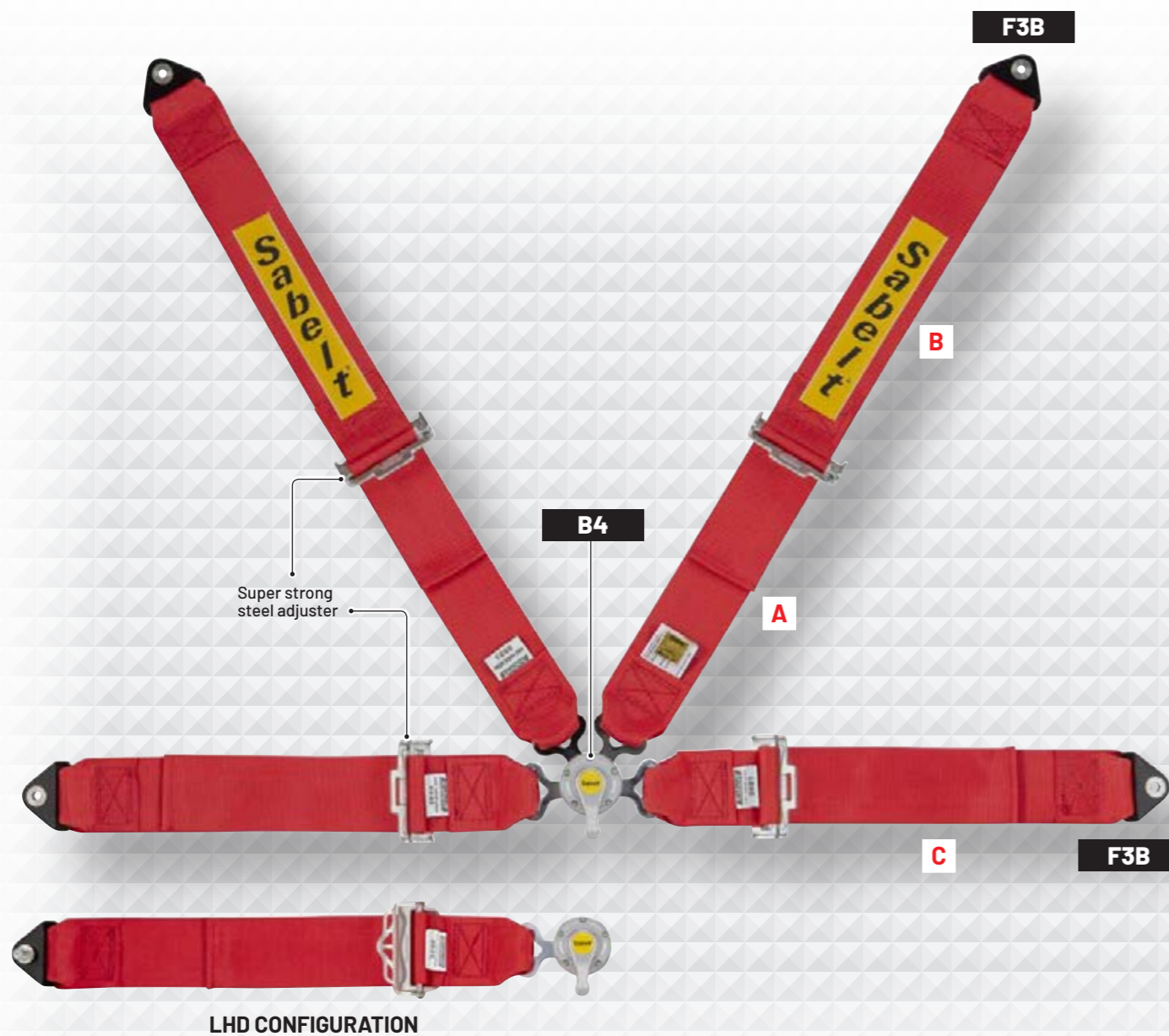

SALOON - FOR KIT CAR "C"				STEEL	FIA 8854/98	
STANDARD MEASURES (mm)				STANDARD COLOURS/CODES		
A	B	C				
480	450	130+610		CCS433SRDN	CCS433SNDN	CCS433SBDN

## CONFIGURATIONS ON DEMAND



# CCS433SRUN

## STANDARD FEATURES

SALOON				STEEL	FIA 8854/98	
STANDARD MEASURES (mm)				STANDARD COLOURS/CODES		
A	B	C				
380	1700	560+120		CCS433SRUN	CCS433SNUN	CCS433SBUN



## EYE BOLTS AND PLATES



**407005\_C**  
Standard eye-bolt diam. 7/16" UNF thread length 23 mm, 25 mm tot., 8.8.



**CCM10023**  
Eye-bolt metric M10 x 1.5 thread length 23 mm, 8.8. Does not comply with FIA requirements.



**CCM10017\_A WESTFIELD**  
Eye-bolt 50 mm. long, 7/16", 8.8





**CCM10016**  
Eye-bolt back plate 65 mm x 65 mm x 3 mm 7/16" UNF thread welded nut, 40 mm<sup>2</sup>. Complies with FIA requirements.

## PADS



Vep fabric shoulder cover. 75 mm (3") width. Velcro fastening.

		
475040	475020	475010



Vep fabric shoulder cover. 50 mm (2") width. Velcro fastening.

		
450040/S	450020/S	450010/S

## COLORED GADGET KIT FOR ENDURANCE BUCKLES B1 TYPE





**CCAC0104\_KIT**  
Straps.  
**NEW**

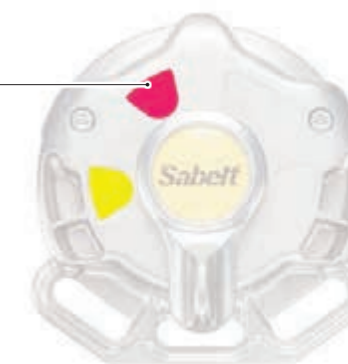

**CCET0408\_KIT**  
Stickers.  
**NEW**



**CFCC4046****SALOON**



FIXING POINTS	4
HOMOLOGATION	NOT HOMOLOGATED
STANDARD COLOURS/CODES	
	CFCC4046
	CFCC2046
	CFCC1046

Available on demand buckle with switch for SBR sensor



AVAILABLE  
ON DEMAND

**CFCC904001NP\_A****SALOON**



FIXING POINTS	4
HOMOLOGATION	ECE
Homologation updated to series 08	
STANDARD COLOURS/CODES	
	CFCC904001NP_A
	CFCC902001NP_A
	CFCC901001NP_A

Available on demand buckle with switch for SBR sensor



Pair of shoulder  
pads included.

**CFCC904070NP\_B****SALOON**

FIXING POINTS	4
HOMOLOGATION	ECE
Homologation updated to series 08	
STANDARD COLOURS/CODES	
	CFCC904070NP_B
	CFCC902070NP_B
	CFCC901070NP_B



Available on demand buckle with switch for SBR sensor



Pair of shoulder  
pads included.

AVAILABLE  
ON DEMAND

**CFCC904059NP\_B****SALOON**



FIXING POINTS	3
HOMOLOGATION	ECE
Homologation updated to series 08	
STANDARD COLOURS/CODES	
	CFCC904059NP_B
	CFCC902059NP_B
	CFCC901059NP_B

Available on demand buckle with switch for SBR sensor





Pair of shoulder  
pads included.

**CFCC904005N\_B****SALOON**

FIXING POINTS	3
HOMOLOGATION	ECE
Homologation updated to series 08	
STANDARD COLOURS/CODES	
	CFCC904005N_B
	CFCC902005N_B
	CFCC901005N_B

Available on demand buckle with switch for SBR sensor

**CFCC904002NP\_A****SALOON**

FIXING POINTS	3
HOMOLOGATION	ECE
Homologation updated to series 08	
STANDARD COLOURS/CODES	
	CFCC904002NP_A
	CFCC902002NP_A
	CFCC901002NP_A



Available on demand buckle with switch for SBR sensor



Pair of shoulder  
pads included.

# CCS622SNUSFI

## STANDARD FEATURES

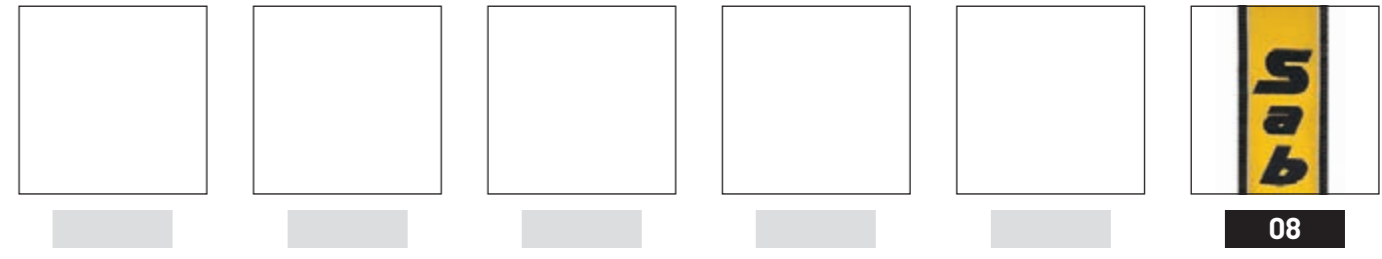

				STEEL	SFI 16.1	
STANDARD MEASURES (MM)				STANDARD COLOURS/CODES		
A	B	C	D			
440	1700	560+120	1080	CCS622SRUSFI	CCS622SNUSFI	CCS622SBUSFI

## CONFIGURATIONS ON DEMAND



# CCS533SNULLSFI

## STANDARD FEATURES

				STEEL	SFI 16.1	
STANDARD MEASURES (mm)				STANDARD COLOURS/CODES		
A	B	C	D			
380	1700	680	770	CCS533SRULLSFI	CCS533SNULLSFI	CCS533SBULLSFI

## CONFIGURATIONS ON DEMAND

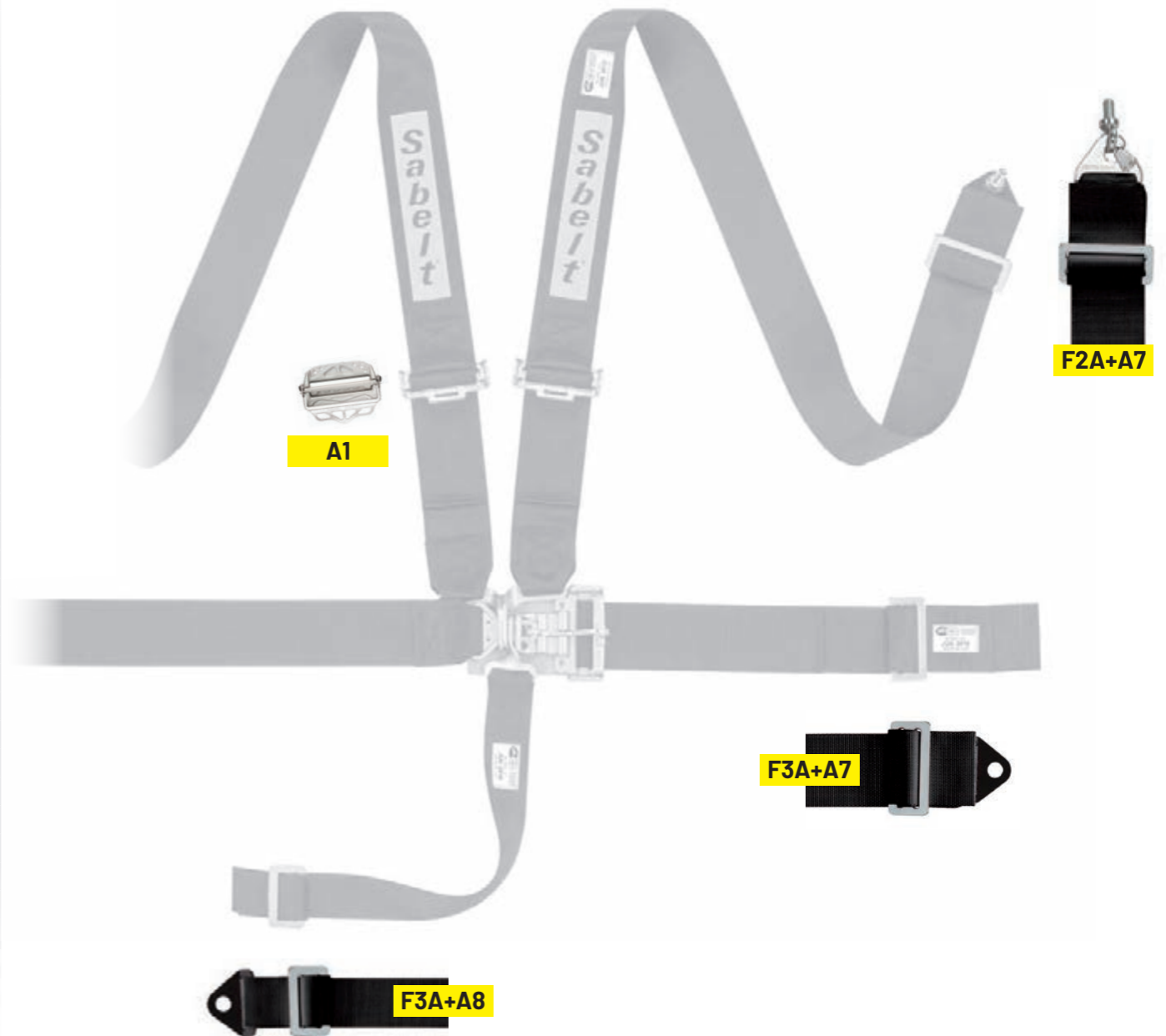
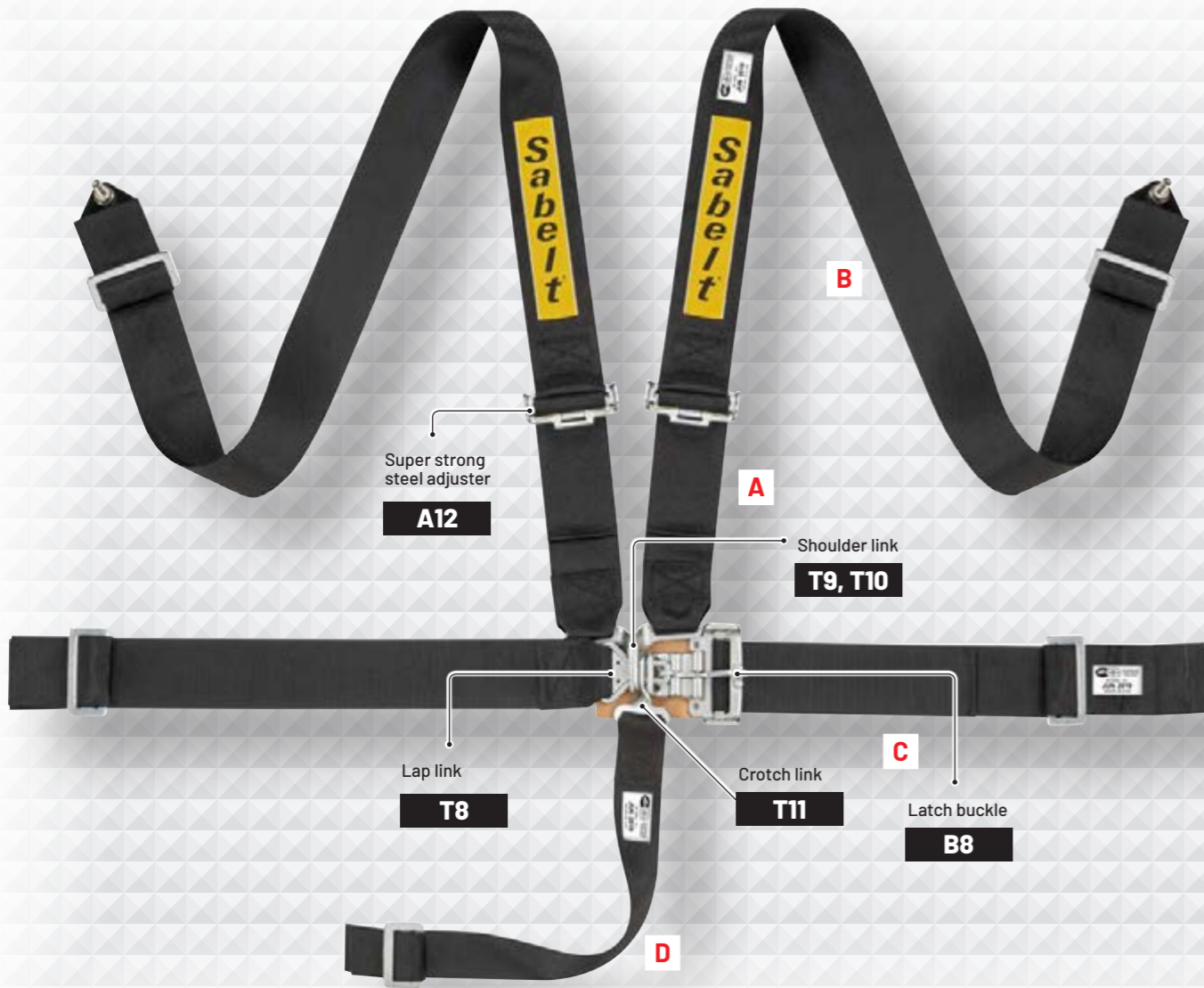
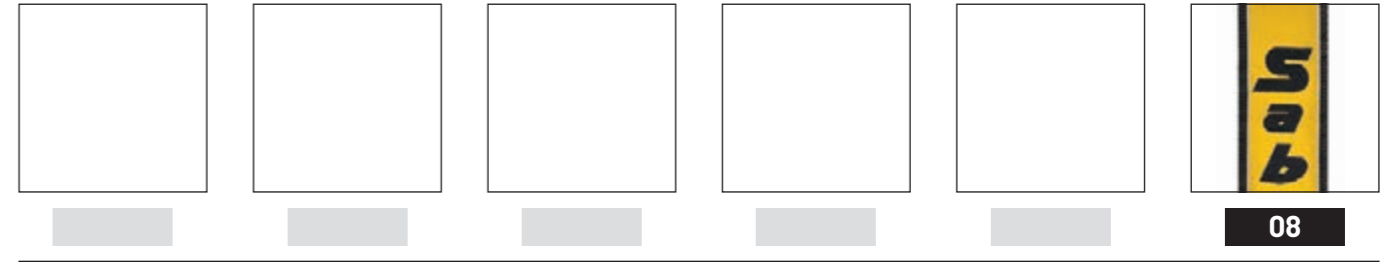

# CFRN2008

RACING NET

NEW



MANUFACTURER: SABELT  
MODEL: CFRN2008  
HOM. NO: RN.025.21  
FIA STANDARD: 8863-2013

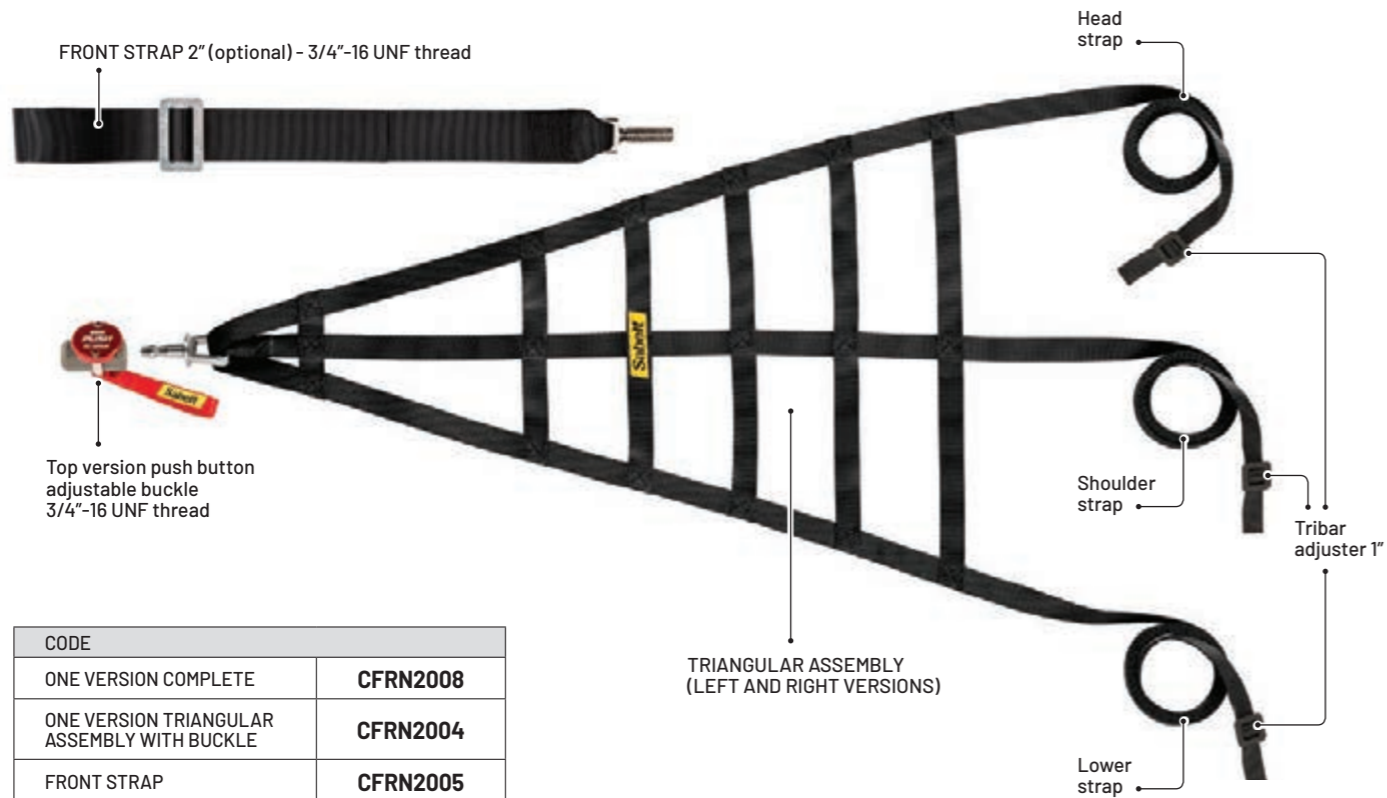

CODE	
ONE VERSION COMPLETE	<b>CFRN2008</b>
ONE VERSION TRIANGULAR ASSEMBLY WITH BUCKLE	<b>CFRN2004</b>
FRONT STRAP	<b>CFRN2005</b>

# CFRN2002

RACING NET



MANUFACTURER: SABELT  
MODEL: CFRN2002  
HOM. NO: RN.020.20  
FIA STANDARD: 8863-2013

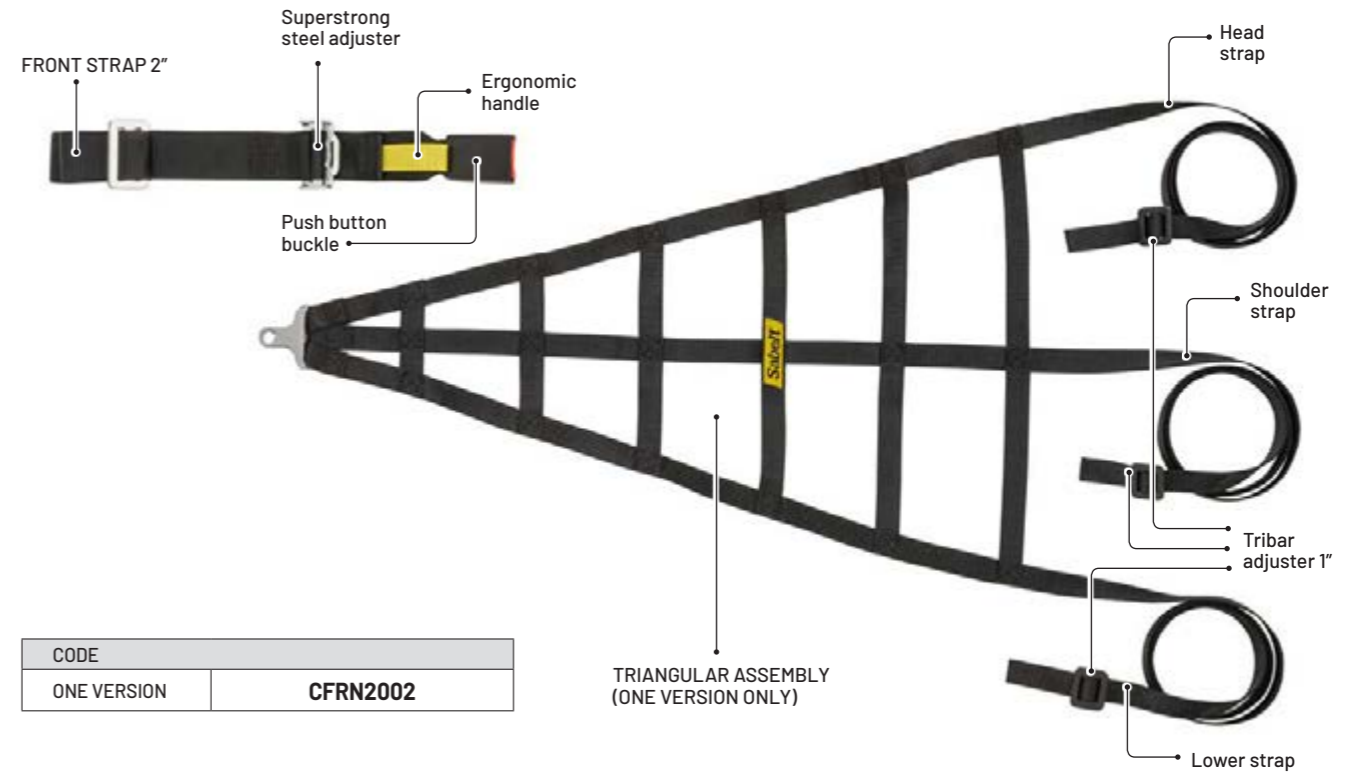

CODE	
ONE VERSION	<b>CFRN2002</b>

# CFRN2003

RACING NET



MANUFACTURER: SABELT  
MODEL: CFRN2003  
HOM. NO: RN.015.18  
FIA STANDARD: 8863-2013

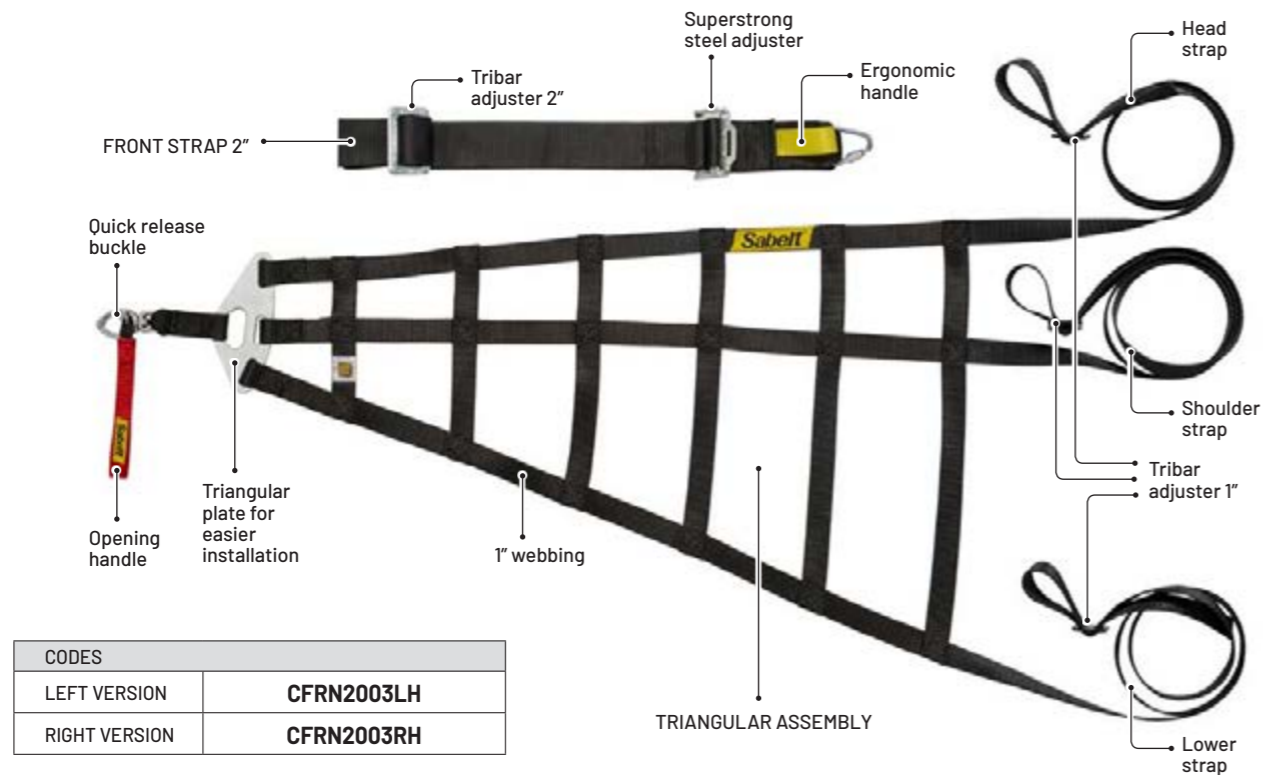

CODES	
LEFT VERSION	<b>CFRN2003LH</b>
RIGHT VERSION	<b>CFRN2003RH</b>

# Z280988

WINDOW NET

Professional window net. • Quick release with push button  
• Rollcage fixing clamps • Tightening adjusters  
• Rigid metal bars • Polyester webbing  
In compliance with Fia regulation.

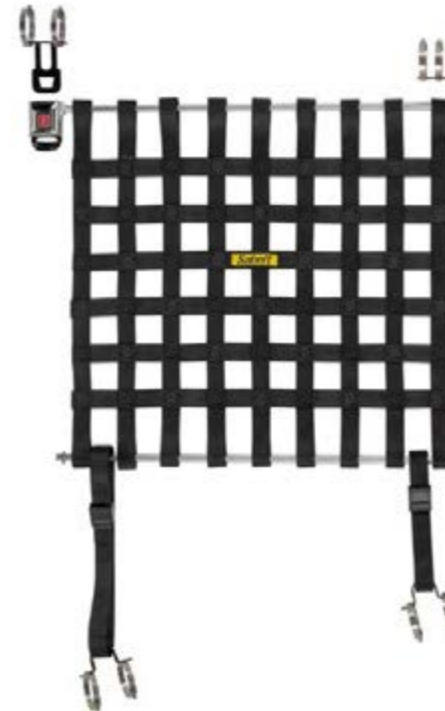

# Z280985

WINDOW NET

Professional window net • Red webbing opening System • Rollcage mounting  
• Tightening adjusters • Polyester webbing  
In compliance with Fia regulation.

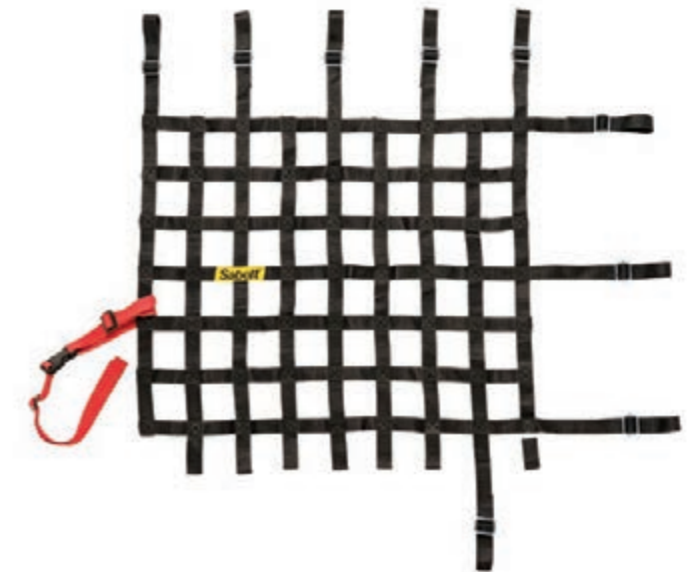



# SEATS

**Sabelt**

**Sabelt**



OFFICIAL SUPPLIER

**PORSCHE**  
MOTORSPORT

## FIA 8862-2009

## GT/RALLY/CIRCUIT

**GT-PRO**

- Shell: CARBON
- Fixing: BRACKETS
- Size: M-L-XL

**GT-635**

- Shell: CARBON
- Fixing: BRACKETS
- Size: M-L-XL

**GT-621**

- Shell: CARBON
- Fixing: BRACKETS
- Size: M-L

## CIRCUIT ONLY

**GT-PRO XL 6-POINT**

- Shell: CARBON
- Fixing: BRACKETS
- Size: XL

**GT-635**

- Shell: CARBON
- Fixing: BRACKETS/SLIDING TRACKS
- Size: M-L-XL

**GT-E**

- Shell: CARBON
- Fixing: BRACKETS
- Size: M

## SFI 39.1

## NASCAR

**GT-910**

- Shell: CARBON
- Fixing: BRACKETS
- Size: M

## FIA 8855-2021 • NEW HOMOLOGATION

## HEAD PROTECTION

**SPINE**

- Shell: FIBERGLASS
- Fixing: BRACKETS
- Size: L-XL

**NEW****GT-AM**

- Shell: FIBERGLASS
- Fixing: BRACKETS
- Size: M-L-XL

**NEW**

## FIA 8855-1999

## HEAD PROTECTION

**X-PAD CARBON**

- Shell: CARBON
- Fixing: BRACKETS
- Size: L

**X-PAD RALLYCROSS**

- Shell: FIBERGLASS
- Fixing: BRACKETS
- Size: L

**X-PAD**

- Shell: FIBERGLASS
- Fixing: BRACKETS
- Size: L

**GT-PAD**

- Shell: FIBERGLASS
- Fixing: BRACKETS
- Size: M-L-XL

**TAURUS**

- Shell: FIBERGLASS
- Fixing: BRACKETS
- Size: M-L-XL

## NO HEAD PROTECTION

**TITAN CARBON**

- Shell: CARBON
- Fixing: BRACKETS
- Size: L-XL

**TITAN**

- Shell: FIBERGLASS
- Fixing: BRACKETS
- Size: XL

**GT-3**

- Shell: FIBERGLASS
- Fixing: BRACKETS
- Size: L

**RACER DUO**

- Shell: STEEL TUBE
- Fixing: BRACKETS
- Size: L

## CUSHIONS - TITAN / TAURUS

**S1**

Seatback cushion th. 20 mm

TITAN	RRTITAU002_A
TITAN MAX	RRTITAU003_A
TAURUS	RRTITAU002_A
TAURUS MAX	RRTITAU003_A

**CS1**

Lower cushion th. 20 mm

TITAN	RRTITAU004_A
TITAN MAX	RRTITAU007_A
TAURUS	RRTITAU004_A
TAURUS MAX	RRTITAU007_A

**CS2**

Lower cushion th. 40 mm

TITAN	RRTITAU005_A
TITAN MAX	RRTITAU008_A
TAURUS	RRTITAU005_A
TAURUS MAX	RRTITAU008_A

**CS3**

Lower cushion th. 50 mm

TITAN	RRTITAU006_A
TITAN MAX	RRTITAU009_A
TAURUS	RRTITAU006_A
TAURUS MAX	RRTITAU009_A

**PG1**

Leg cushion th. 40 mm

TITAN	RRTITAU010_A
TITAN MAX	RRTITAU012_A
TAURUS	RRTITAU010_A
TAURUS MAX	RRTITAU012_A

**PG2**

Leg cushion th. 50 mm

TITAN	RRTITAU011_A
TITAN MAX	RRTITAU013_A
TAURUS	RRTITAU011_A
TAURUS MAX	RRTITAU013_A

**CPR**

Lower back support

RRTITAU014_A
--------------

**CL**

Lumbar support

RRTITAU001_A
--------------

## CUSHIONS - GT-PRO / GT-AM

**S3**

Seatback cushion th. 20 mm

RRGTPRO0014

**NEW****CS5**

Seat cushion

th. 20 mm	RRGTPRO0016
th. 40 mm	RRGTPRO0040

**NEW****CS4**

Leg cushion

th. 20 mm	RRGTPRO0015
th. 40 mm	RRGTPRO0045

**NEW****S2**

Size pads

th. 10 mm	RRGTPRO0041
th. 20 mm	RRGTPRO0042
th. 25 mm	RRGTPRO0043
th. 30 mm	RRGTPRO0044

**NEW**

## SET

**KF**

Seat cover kit.

GT-621 Size M	RRGT621019
GT-621 Size L	RRGT621020
GT-625 Size L	RRGT625018
GT-635 Size M	RRGT635015
GT-635 Size L	RRGT635016
GT-635 Size XL	RRGT635017

**KFP**

Seat cover kit with bezels.

TITAN	RRTITAN021
TITAN MAX	RRTITAN022
TITAN CARBON	RRTITCAR026
TITAN MAX CARBON	RRTITCAR027
TAURUS M	RRTAURUS023
TAURUS	RRTAURUS024
TAURUS MAX	RRTAURUS025

## HARNESS SLOT

**KP1**

Bezels for 8855 seats.

RCB00009 - RCB00010

**KP2**

Bezels for 8855 seats.

RCB00007 - RCB00008

**MP**

Bezel for GT-635 and GT-625.

RCB00011

## INDI SEAT - Sabelt Official Distributor



Inner seat customization kit

RCIM0002

**NEW**

## FIXING FRAMES

**F1**

Steel brackets, th. 3mm, in compliance with FIA.  
Z200087\_A

**F2**

Aluminium brackets, th. 5 mm, in compliance with FIA.  
Z20005\_C

**F3**

Sliding tracks, travel 230 mm. No FIA.  
Z200002\_A

**F4**

Steel brackets for GT-635, Fia homologated. Bolts included.  
Note: Specify the seat size during the order.  
RCST635FIX

**F5**

Sliding tracks for GT-635. FIA Homologated. Bolts included.  
Size M: RCST635SLIDINGM  
Size L/XL: RCST635SLIDINGXL

**F6**

Steel brackets for GT-621, FIA homologated. Bolts included.  
XRFST0007

**F8**

Brackets for GT-PRO M. FIA Homologated. Bolts included.  
RFST0025

**F10**

Steel brackets for GT-E, FIA homologated. Bolts included.  
RCST0005

**F11**

**NEW**  
Brackets for GT-PRO XL. FIA Homologated. Bolts included.  
RFST0032 - RFST0033 - RFST0036  
RFST0038 - RFST0047

**F12** **NEW**

Steel bracket for 8855-2021 homologated seats. Bolts included.  
RFST0051

## LEGEND SEAT DIMENSIONS CHART

## SHELL DIMENSIONS (mm)

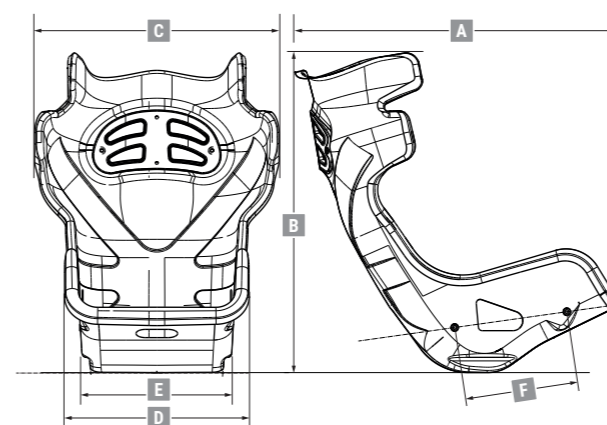

A	Length
B	Height
C	External shoulder width
D	External lower frontal width
E	External lower rear width
F	Lateral interaxis distance
⚖	Shell weight (kg)

## INTERNAL SEAT DIMENSIONS (mm)



G	Rear lower cushion width
H	Frontal lower cushion width
I	Internal shoulder width
L	Central seatback width
M	Internal head protection width
N	Central bezel height
⚖	Seat weight (kg)

SEAT FLOOR FIXING INTERAXIS

8862-2009 / 8855-2021

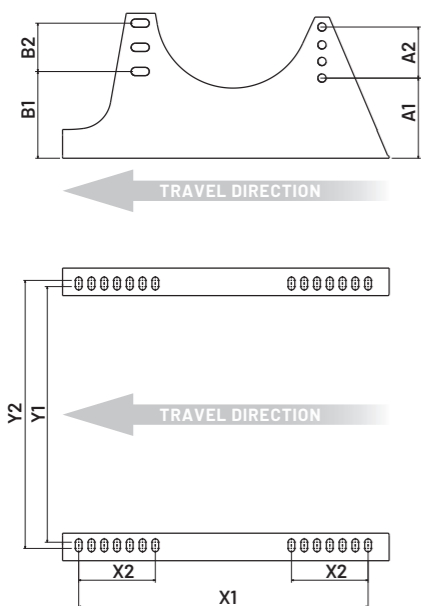

8855-1999

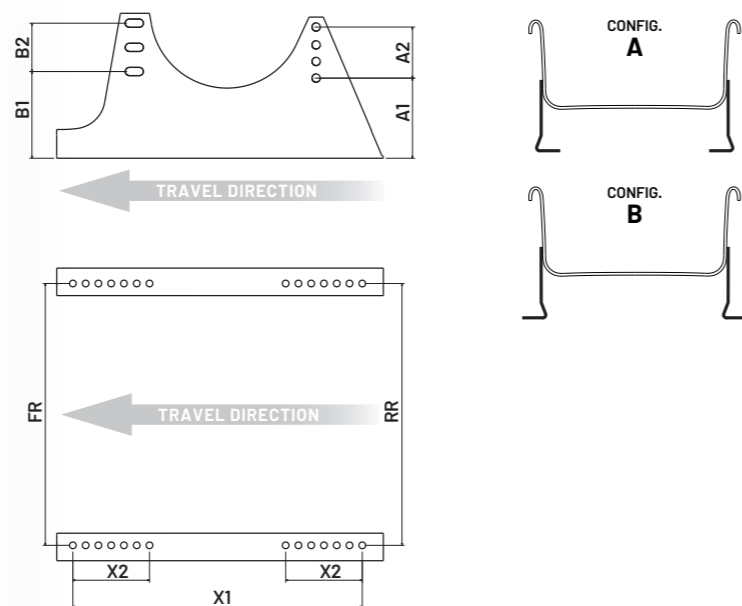

8862-2009

GTPRO															
		A1(mm)	A2(mm)	B1(mm)	B2(mm)	Y1(mm)	Y2(mm)	X1(mm)	X2(mm)	CHASSIS FIXING			SEAT FIXING		
										SCREW	Q.TY	STRENGTH CLASS	SCREW	Q.TY	STRENGTH CLASS
F8	RFST0025	58,5	20	105	22	428,5	435,5	406,5	40	M8	8	12,9	M12	4	12,9
	RFST0028	73		119,5	22,5	416	448	406,5	40	M8	8	12,9	M12	4	12,9
F11	RFST0032	67,5	30	84,5	60	475,4	488,4	401	59	M8	8	12,9	M12	4	12,9
	RFST0033	127	30	144	60	475,4	488,4	401	59	M8	8	12,9	M12	4	12,9
	RFST0036	94	/	124,5	23	418,5	445	406,5	40	M8	8	12,9	M12	4	12,9
	RFST0038	50,5	20	84	20	473	483	391,8	40	M8	8	12,9	M12	4	12,9
	RFST0047	90,5	20	124	40	472,7	482,5	391,8	40	M8	8	12,9	M12	4	12,9

GT-635 M e XL															
		A1(mm)	A2(mm)	B1(mm)	B2(mm)	Y1(mm)	Y2(mm)	X1(mm)	X2(mm)	CHASSIS FIXING			SEAT FIXING		
										SCREW	Q.TY	STRENGTH CLASS	SCREW	Q.TY	STRENGTH CLASS
F4	RFST0011	106	18	146	34	432		406,5	40	M8	8	12,9	M12	4	12,9
F5	RFST635M_LA RFST635XL_LA	106	18	146	34	432		406,5		M8	8	12,9	M12	4	12,9

GT-621															
		A1(mm)	A2(mm)	B1(mm)	B2(mm)	Y1(mm)	Y2(mm)	X1(mm)	X2(mm)	CHASSIS FIXING			SEAT FIXING		
										SCREW	Q.TY	STRENGTH CLASS	SCREW	Q.TY	STRENGTH CLASS
F6	XRFST0007	26,7	18,5	109,5	17	484	499,7	380	/	M10	4	MIN 10.9	M12	4	12,9

GTE															
		A1(mm)	A2(mm)	B1(mm)	B2(mm)	Y1(mm)	Y2(mm)	X1(mm)	X2(mm)	CHASSIS FIXING			SEAT FIXING		
										SCREW	Q.TY	STRENGTH CLASS	SCREW	Q.TY	STRENGTH CLASS
F10	RCST0005	170,5	20	160	20	479	/	382,5	50	M12	4	12,9	M12	4	12,9

8855-2021

SPINE															
		A1(mm)	A2(mm)	B1(mm)	B2(mm)	Y1(mm)	Y2(mm)	X1(mm)	X2(mm)	CHASSIS FIXING			SEAT FIXING		
										SCREW	Q.TY	STRENGTH CLASS	SCREW	Q.TY	STRENGTH CLASS
F12	RFST0051	125,5	80	136	75,5	419	438,5	453	120	M10	4	12,9	M12	4	12,9

GT-AM															
		A1(mm)	A2(mm)	B1(mm)	B2(mm)	Y1(mm)	Y2(mm)	X1(mm)	X2(mm)	CHASSIS FIXING			SEAT FIXING		
										SCREW	Q.TY	STRENGTH CLASS	SCREW	Q.TY	STRENGTH CLASS
F12	RFST0051	125,5	80	136	75,5	413	429	453	120	M10	4	12,9	M12	4	12,9

8855-1999

X-PAD														
		CONFIG.	A1(mm)	A2(mm)	B1(mm)	B2(mm)	FR(mm)	RR(mm)	X1(mm)	X2(mm)	CHASSIS FIXING		SEAT FIXING	
											SCREW	Q.TY	SCREW	Q.TY
F1	Z200087_A	A	70,5	54	72	72	356	349	329,5	36	M8	4	M8	4
	Z200087_A	B	70,5	54	72	72	444	438	329,5	36	M8	4	M8	4
F2	Z20005_C	A	63	79,5	63	79,5	348	343,4	324	34	M8	4	M8	4
	Z20005_C	B	63	79,5	63	79,5	456	447,6	324	34	M8	4	M8	4

GT-PAD														
		CONFIG.	A1(mm)	A2(mm)	B1(mm)	B2(mm)	FR(mm)	RR(mm)	X1(mm)	X2(mm)	CHASSIS FIXING		SEAT FIXING	
											SCREW	Q.TY	SCREW	Q.TY
F1	Z200087_A	A	70,5	54	72	72	426	418	329,5	36	M8	4	M8	4
	Z200087_A	B	70,5	54	72	72	518	508	329,5	36	M8	4	M8	4
F2	Z20005_C	A	63	79,5	63	79,5	422	415	324	34	M8	4	M8	4
	Z20005_C	B	63	79,5	63	79,5	534	518	324	34	M8	4	M8	4

TAURUS M														
		CONFIG.	A1(mm)	A2(mm)	B1(mm)	B2(mm)	FR(mm)	RR(mm)	X1(mm)	X2(mm)	CHASSIS FIXING		SEAT FIXING	
											SCREW	Q.TY	SCREW	Q.TY
F1	Z200087_A	A	70,5	54	72	72	352,6	335,3	329,5	36	M8	4	M8	4
	Z200087_A	B	70,5	54	72	72	441,8	424,5	329,5	36	M8	4	M8	4
F2	Z20005_C	A	63	79,5	63	79,5	345,2	329,9	324	34	M8	4	M8	4
	Z20005_C	B	63	79,5	63	79,5	453,2	433,9	324	34	M8	4	M8	4

TAURUS L														
		CONFIG.	A1(mm)	A2(mm)	B1(mm)	B2(mm)	FR(mm)	RR(mm)	X1(mm)	X2(mm)	CHASSIS FIXING		SEAT FIXING	
											SCREW	Q.TY	SCREW	Q.TY
F1	Z200087_A	A	70,5	54	72	72	358,8	350,7	329,5	36	M8	4	M8	4
	Z200087_A	B	70,5	54	72	72	448	439,9	329,5	36	M8	4	M8	4
F2	Z20005_C	A	63	79,5	63	79,5	351,4	345,3	324	34	M8	4	M8	4
	Z20005_C	B	63	79,5	63	79,5	459,4	449,3	324	34	M8	4	M8	4

TAURUS XL														
		CONFIG.	A1(mm)	A2(mm)	B1(mm)	B2(mm)	FR(mm)	RR(mm)	X1(mm)	X2(mm)	CHASSIS FIXING		SEAT FIXING	
											SCREW	Q.TY	SCREW	Q.TY
F1	Z200087_A	A	70,5	54	72	72	381,5	350,7	329,5	36	M8	4	M8	4
	Z200087_A	B	70,5	54	72	72	470,7	439,9	329,5	36	M8	4	M8	4
F2	Z20005_C	A	63	79,5	63	79,5	374,1	345,3	324	34	M8	4	M8	4
	Z20005_C	B	63	79,5	63	79,5	482,1	449,3	324	34	M8	4	M8	4

TITAN XL														
		CONFIG.	A1(mm)	A2(mm)	B1(mm)	B2(mm)	FR(mm)	RR(mm)	X1(mm)	X2(mm)	CHASSIS FIXING		SEAT FIXING	
											SCREW	Q.TY	SCREW	Q.TY
F1	Z200087_A	A	70,5	54	72	72	382,3	373,9	329,5	36	M8	4	M8	4
	Z200087_A	B	70,5	54	72	72	471,5	463,1	329,5	36	M8	4	M8	4
F2	Z20005_C	A	63	79,5	63	79,5	374,9	368,5	324	34	M8	4	M8	4
	Z20005_C	B	63	79,5	63	79,5	482,9	472,5	324	34	M8	4	M8	4

GT-3														
		CONFIG.	A1(mm)	A2(mm)	B1(mm)	B2(mm)	FR(mm)	RR(mm)	X1(mm)	X2(mm)	CHASSIS FIXING		SEAT FIXING	
											SCREW	Q.TY	SCREW	Q.TY
F1	Z200087_A	A	70,5	54	72	72	390,1	374,2	329,5	36	M8	4	M8	4
	Z200087_A	B	70,5	54	72	72	479,3	463,4	329,5	36	M8	4	M8	4
F2	Z20005_C	A	63	79,5	63	79,5	382,7	368,8	324	34	M8	4	M8	4
	Z20005_C	B	63	79,5	63	79,5	490,7	472,8	324	34	M8	4	M8	4

RACER DUO														
		CONFIG.	A1(mm)	A2(mm)	B1(mm)	B2(mm)	FR(mm)	RR(mm)	X1(mm)	X2(mm)	CHASSIS FIXING		SEAT FIXING	
											SCREW	Q.TY	SCREW	Q.TY
F1	Z200087_A	A	70,5	54	72	72	381,8	380,4	329,5	36	M8	4	M8	4
	Z200087_A	B	70,5	54	72	72	471	469,6	329,5	36	M8	4	M8	4
F2	Z20005_C	A	63	79,5	63	79,5	374,4	375	324	34	M8	4	M8	4
	Z20005_C	B	63	79,5	63	79,5	482,4	479	324	34	M8	4	M8	4

# GT-PRO

8862-2009

GT/RALLY/CIRCUIT

CARBON	SHELL SIZE	FIXING	FIA
	M - XL	BRACKETS	8862-2009

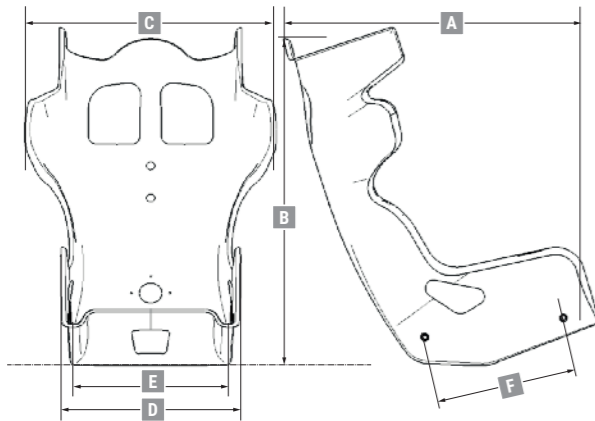

	Sizes		
	M	L	XL
<b>SHELL DIMENSIONS (mm)</b>			
A	825	795	
B	770	770	
C	625	644	
D	443	482	
E	389	427	
F	340	340	
Ⓜ	8,5	9,3	
<b>INTERNAL SEAT DIMENSIONS (mm)</b>			
G	302	325	340
H	343	335	350
I	430	440	450
L	321	340	370
M	328	330	330
N	512	512	512
Ⓜ	10,1	11,2	11,2



FIXING BRACKETS



FLOOR FIXING

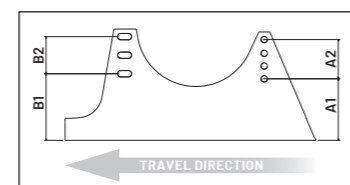

SEE SCHEME ON PAGE 68



• Size: **M**  
• Cod: **RFSEGTPROPADM**



MANUFACTURER: SABELT  
MODEL: GT-PRO M  
HOM. NO: AS.081.19  
FIA STANDARD: 8862-2009

• Size: **L**  
• Cod: **RFSEGTPROPADL**



MANUFACTURER: SABELT  
MODEL: GT-PRO XL  
HOM. NO: AS.086.20  
FIA STANDARD: 8862-2009

• Size: **XL**  
• Cod: **RFSEGTPROPADXL**



MANUFACTURER: SABELT  
MODEL: GT-PRO XL  
HOM. NO: AS.086.20  
FIA STANDARD: 8862-2009

# GT-635

8862-2009

CIRCUIT ONLY (with sliding tracks) - GT/RALLY/CIRCUIT (with fixed brackets)

CARBON	SHELL SIZE	FIXING	FIA
	M - XL	BRACKETS	8862-2009

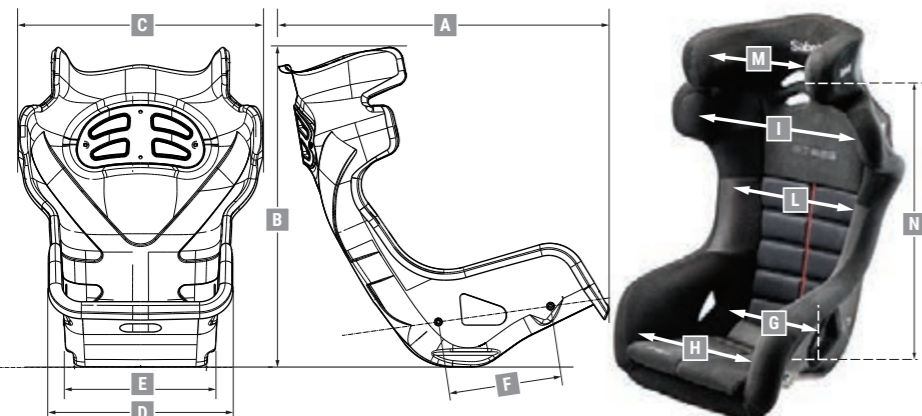

	Sizes		
	M	L	XL
<b>SHELL DIMENSIONS (mm)</b>			
A	530	540	
B	910	930	
C	656	676	
D	472	502	
E	400	430	
F	290	290	
⊕	8,4	11,3	
<b>INTERNAL SEAT DIMENSIONS (mm)</b>			
G	316	337	357
H	349	364	384
I	541	546	566
L	368	417	437
M	317	325	325
N	670	656	656
⊕	10,9	13,8	13,5

## SPARES AND ACCESSORIES



KF



## FIXING BRACKETS



F4 GT/CIRCUIT



F5 CIRCUIT ONLY

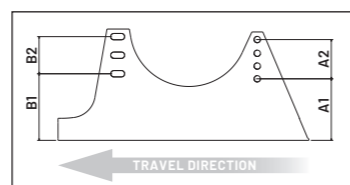

SEE SCHEME ON PAGE 68

## FLOOR FIXING



### • CIRCUIT ONLY

• with sliding tracks

• Size: **M**

• Cod: **RFSEGT635DMN**



MANUFACTURER: SABELT  
MODEL: GT-635 M  
HOM. NO: AS.057.16  
FIA STANDARD: 8862-2009

• Size: **L**

• Cod: **RFSEGT635DLN**



MANUFACTURER: SABELT  
MODEL: GT-635 XL  
HOM. NO: AS.058.16  
FIA STANDARD: 8862-2009

• Size: **XL**

• Cod: **RFSEGT635DXLN**



MANUFACTURER: SABELT  
MODEL: GT-635 XL  
HOM. NO: AS.058.16  
FIA STANDARD: 8862-2009

### • GT/RALLY/CIRCUIT

• with fixed brackets

• Size: **M**

• Cod: **RFSEGT635MN**



MANUFACTURER: SABELT  
MODEL: GT-635 M  
HOM. NO: AS.060.16  
FIA STANDARD: 8862-2009

• Size: **L**

• Cod: **RFSEGT635LN**



MANUFACTURER: SABELT  
MODEL: GT-635 XL  
HOM. NO: AS.061.16  
FIA STANDARD: 8862-2009

• Size: **XL**

• Cod: **RFSEGT635XLN**



MANUFACTURER: SABELT  
MODEL: GT-635 XL  
HOM. NO: AS.061.16  
FIA STANDARD: 8862-2009

# GT-PRO XL 6-POINT

8862-2009

CIRCUIT ONLY

CARBON	SHELL SIZE	FIXING	FIA
	XL	BRACKETS	8862-2009

Sizes	
XL	
SHELL DIMENSIONS (mm)	
A	795
B	770
C	644
D	482
E	427
F	340
Ⓛ	9,3
INTERNAL SEAT DIMENSIONS (mm)	
G	346
H	350
I	510
L	372
M	350
N	512
Ⓛ	11

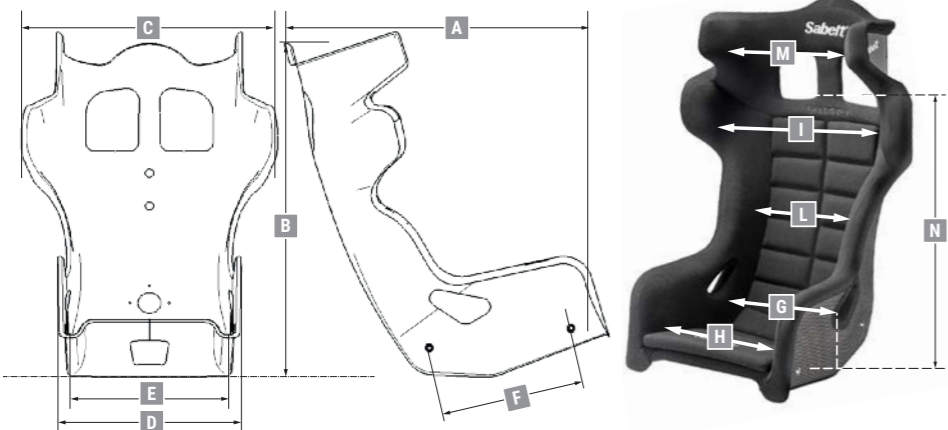

FIXING BRACKETS



F11



--

FLOOR FIXING

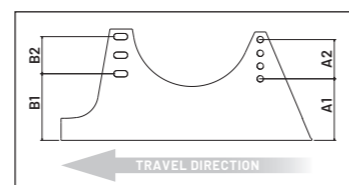

SEE SCHEME ON PAGE 68



• Size: XL  
• Cod: RFSEGTPROXP6PN



MANUFACTURER: SABELT  
MODEL: GT-PRO XL 6-POINT  
HOM. NO.: AS.087.20  
FIA STANDARD: 8862-2009



# GT-621

8862-2009

GT/RALLY/CIRCUIT

CARBON	SHELL SIZE	FIXING	FIA
	L	BRACKETS	8862-2009

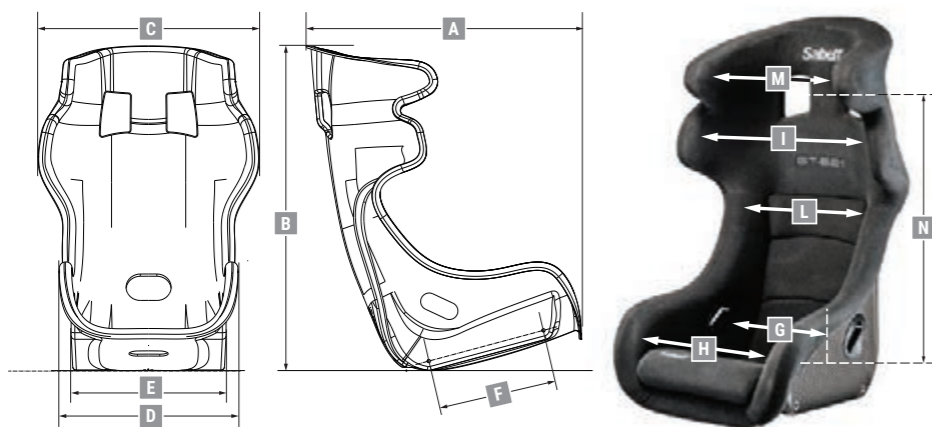

	Sizes	
	M	L
SHELL DIMENSIONS (mm)		
A	567	
B	930	
C	611	
D	497	
E	409	
F	320	
📏	8,5	
INTERNAL SEAT DIMENSIONS (mm)		
G	331	361
H	348	378
I	495	525
L	335	365
M	350	350
N	642	642
📏	11,5	11,0

## SPARES AND ACCESSORIES



KF



CPR



CL

## FIXING BRACKETS



F6

## FLOOR FIXING

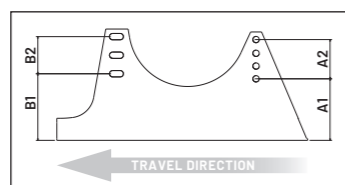

SEE SCHEME ON PAGE 68



• Size: **M**  
 • Cod: **RFSEGT621MN**  
  
 MANUFACTURER: SABELT  
 MODEL: GT-621  
 HOM. NO: AS.056.16  
 FIA STANDARD: 8862-2009

• Size: **L**  
 • Cod: **RFSEGT621LN**  
  
 MANUFACTURER: SABELT  
 MODEL: GT-621  
 HOM. NO: AS.056.16  
 FIA STANDARD: 8862-2009

# GT-E

## 8862-2009

CIRCUIT ONLY

CARBON	SHELL SIZE	FIXING	FIA
	M	BRACKETS	8862-2009

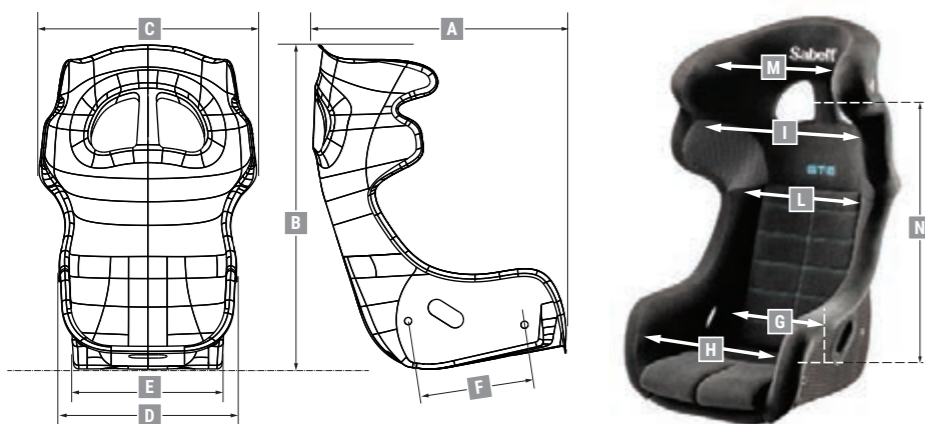

Sizes	
M	
SHELL DIMENSIONS (mm)	
A	580
B	890
C	595
D	540
E	418
F	320
📏	12,6
INTERNAL SEAT DIMENSIONS (mm)	
G	340
H	370
I	495
L	330
M	370
N	700
📏	15,0



### FIXING BRACKETS



F10

### FLOOR FIXING

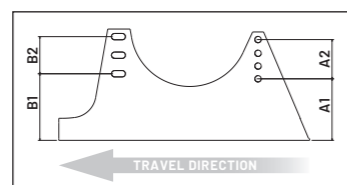

SEE SCHEME ON PAGE 68

- Size: **M**
- Cod: **RFSEGTE**



MANUFACTURER: SABELT  
 MODEL: GT-E  
 HOM. NO: AS.071.18  
 FIA STANDARD: 8862-2009

## GT-910

NASCAR

SFI 39.1

CARBON	SHELL SIZE	SFI
	M	39.1

MADE IN USA

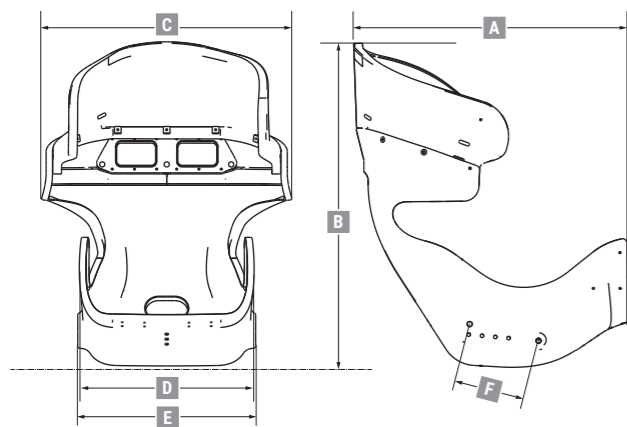

Sizes	
M	
SHELL DIMENSIONS (mm)	
A	779
B	925
C	714
D	499
E	508
F	202
⊕	19,0

Full Carbon, Textreme external layer (unique design).  
 Weight in compliance with new standards (42 lbs weight). Headrest included.  
 Low COG (center of gravity).  
 NASCAR Approved  
 (69G sled test - SFI homologation - NASCAR 2015 quasi-static test).  
 Shell made of seat + asymmetric headrest.  
 Designed along with one of the most prestigious NASCAR Team.  
 The seat is used and appreciated by several Top Drivers.



- Size: **M**
- SHELL - Cod: **RFGT910M**
- HEADREST - Cod: **RCGT911AM**
- HEADREST+1" - Cod: **RCGT913AM**

# SPINE

8855-2021 **NEW**

FIBERGLASS	SHELL SIZE	FIXING	FIA
	XL	BRACKETS	8855-2021

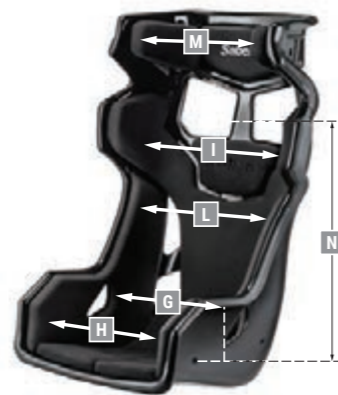
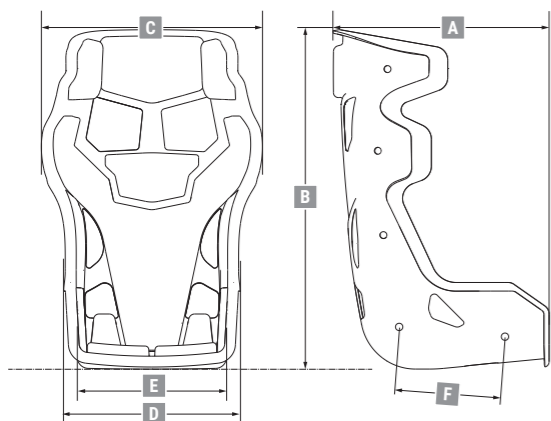

	Sizes	
	L	XL
<b>SHELL DIMENSIONS (mm)</b>		
A	590	
B	924	
C	610	
D	508,5	
E	433,5	
F	290	
Ⓛ	9,5	
<b>INTERNAL SEAT DIMENSIONS (mm)</b>		
G	386,5	406,5
H	383,5	403,5
I	475	490
L	370	385
M	325	325
N	592	592
Ⓛ	11,5	11,3

COMING  
SOON  
SIZE M



FIXING BRACKETS



F12

FLOOR FIXING

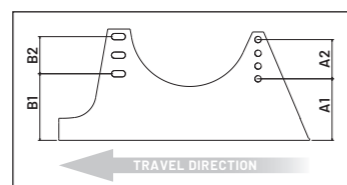

SEE SCHEME ON PAGE 68



• Size: **L**  
 • Cod: **RFSESPINEL**  
  
 MANUFACTURER: SABELT  
 MODEL: SPINE  
 HOM. NO.: .....  
 FIA STANDARD: 8855-2021

• Size: **XL**  
 • Cod: **RFSESPINEXL**  
  
 MANUFACTURER: SABELT  
 MODEL: SPINE  
 HOM. NO.: .....  
 FIA STANDARD: 8855-2021

# GT-AM

8855-2021 **NEW**

FIBERGLASS	SHELL SIZE	FIXING	FIA
	XL	BRACKETS	8855-2021

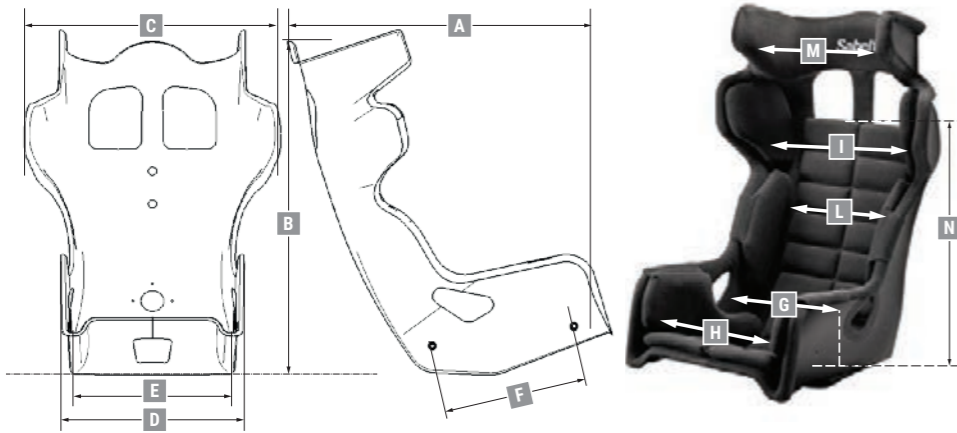

	Sizes		
	M	L	XL
<b>SHELL DIMENSIONS (mm)</b>			
A	795		
B	770		
C	644		
D	482		
E	427		
F	340		
📏	9,5		
<b>INTERNAL SEAT DIMENSIONS (mm)</b>			
G	315	325	340
H	320	335	350
I	432	452	462
L	320	340	370
M	342	342	342
N	512	512	512
📏	11,5	11,5	11,5



FIXING BRACKETS

FLOOR FIXING



F12

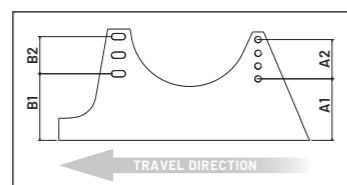

SEE SCHEME ON PAGE 68



• Size: **M**  
 • Cod: **RFSEGTAMM**

**FIA APPROVED**

MANUFACTURER: SABELT  
 MODEL: GT-AM  
 HOM. NO.: .....  
 FIA STANDARD: 8855-2021

• Size: **L**  
 • Cod: **RFSEGTAML**

**FIA APPROVED**

MANUFACTURER: SABELT  
 MODEL: GT-AM  
 HOM. NO.: .....  
 FIA STANDARD: 8855-2021

• Size: **XL**  
 • Cod: **RFSEGTAMXL**

**FIA APPROVED**

MANUFACTURER: SABELT  
 MODEL: GT-AM  
 HOM. NO.: .....  
 FIA STANDARD: 8855-2021

# X-PAD CARBON

8855-1999

CARBON	SHELL SIZE	FIXING	FIA
	L	BRACKETS	8855-1999

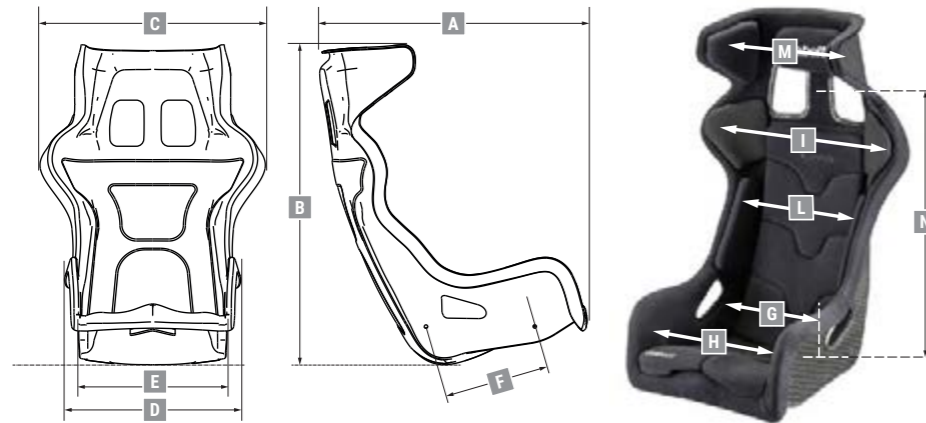

Sizes	
L	
SHELL DIMENSIONS (mm)	
A	550
B	900
C	600
D	396
E	390
F	290
Ⓛ	4,9
INTERNAL SEAT DIMENSIONS (mm)	
G	362
H	368
I	447
L	358
M	338
N	661
Ⓛ	6,3

## PAD KIT

THE KIT INCLUDES ALL THE PADS VISIBLE IN THE PICTURE

COLOUR	SIZE	CODE
■	L	RCXPADNR



## FLOOR FIXING

## FIXING BRACKETS

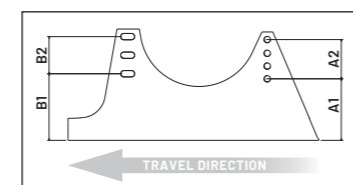

SEE SCHEME ON PAGE 68



• Size: L  
• Cod: RFSEXPADCARBON



MANUFACTURER: SABELT  
MODEL: X-PAD CARBON  
HOM. NO: CS.418.19  
FIA STANDARD: 8855-1999

# X-PAD RALLYCROSS

8855-1999

## RALLYCROSS

FIBERGLASS	SHELL SIZE	FIXING	FIA
	L	BRACKETS	8855-1999

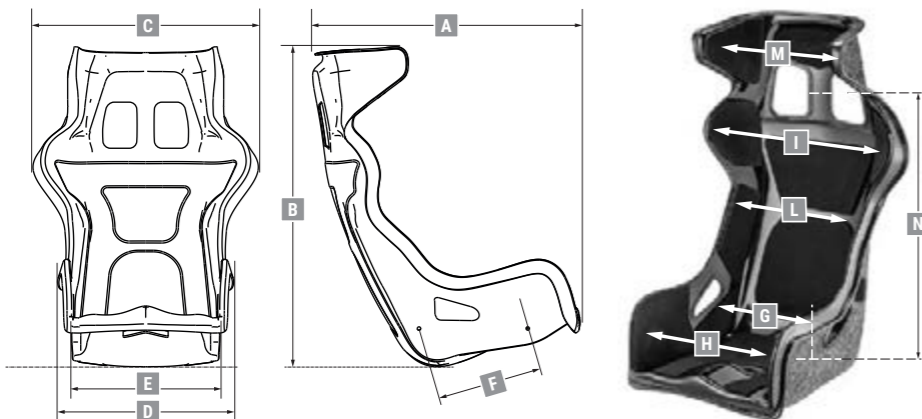

Sizes	
L	
SHELL DIMENSIONS (mm)	
A	550
B	900
C	600
D	396
E	390
F	290
☐	6,5
INTERNAL SEAT DIMENSIONS (mm)	
G	372
H	378
I	460
L	370
M	340
N	661
☐	7,3

### PAD KIT

THE KIT INCLUDES ALL THE PADS VISIBLE IN THE PICTURE

COLOUR	SIZE	CODE
■	L	RCXPADRCROSS3C

EXTRA 2 PADS 30 x 30 cm INCLUDED



### FLOOR FIXING

### FIXING BRACKETS

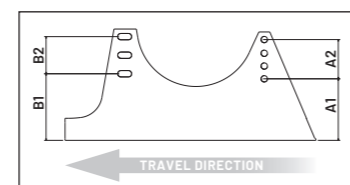

SEE SCHEME ON PAGE 68



EASY TO CLEAN

• Size: L  
 • Cod: RFSEXPADRCROSS  
 (SEAT ONLY WITHOUT PADDING KIT)

**FIA APPROVED**

MANUFACTURER: SABELT  
 MODEL: X-PAD  
 HOM. NO: CS.419.19-  
 FIA STANDARD: 8855-1999

# X-PAD

8855-1999

FIBERGLASS	SHELL SIZE	FIXING	FIA
	L	BRACKETS	8855-1999

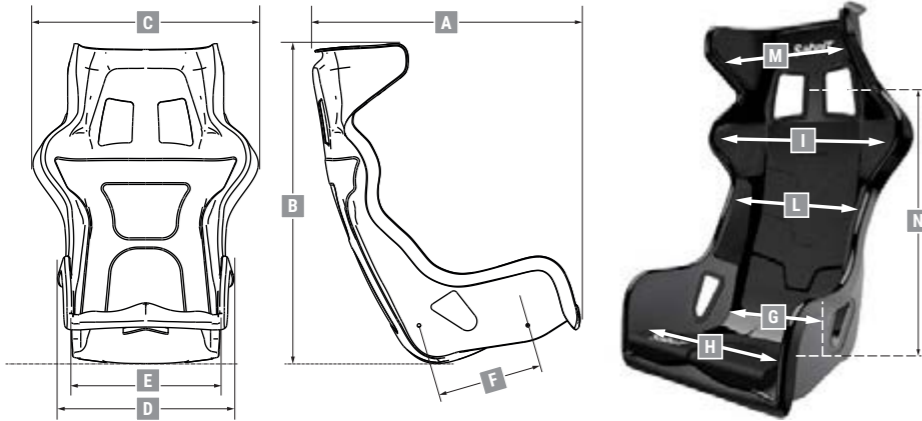

Sizes	
L	
SHELL DIMENSIONS (mm)	
A	550
B	900
C	600
D	396
E	390
F	290
Ⓛ	6,0
INTERNAL SEAT DIMENSIONS (mm)	
G	362
H	368
I	447
L	358
M	338
N	661
Ⓛ	7,7

## PAD KIT

THE KIT INCLUDES ALL THE PADS VISIBLE IN THE PICTURE

COLOUR	SIZE	CODE
■	L	RCXPADNR



## FIXING BRACKETS



## FLOOR FIXING

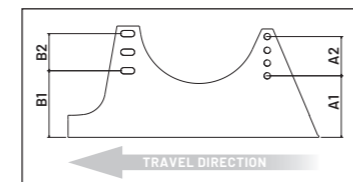

SEE SCHEME ON PAGE 68



• Size: L  
• Cod: RFSEXPADNR



MANUFACTURER: SABELT  
MODEL: X-PAD  
HOM. NO: CS.419.19  
FIA STANDARD: 8855-1999



# GT-PAD

8855-1999

FIBERGLASS	SHELL SIZE	FIXING	FIA
	XL	BRACKETS	8855-1999

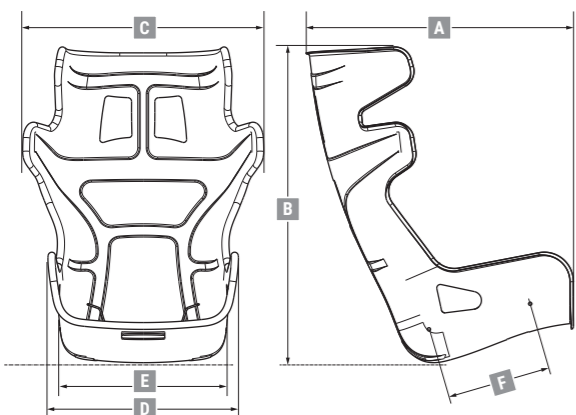

	Sizes		
	M	L	XL
<b>SHELL DIMENSIONS (mm)</b>			
A	744		
B	878		
C	670		
D	529		
E	471		
F	290		
⊥	8,9		
<b>INTERNAL SEAT DIMENSIONS (mm)</b>			
G	365	380	395
H	405	420	435
I	540	550	560
L	346	356	366
M	380	380	380
N	660	660	660
⊥	10,7	10,6	10,5

## PAD KITS

THE KIT INCLUDES ALL THE PADS VISIBLE IN THE PICTURE

COLOUR	SIZE	CODE
Black	M	RCGTPADKITMN
Black	L	RCGTPADKITLN
Black	XL	RCGTPADKITXLN
Red	M	RCGTPADKITMR
Red	L	RCGTPADKITLR
Red	XL	RCGTPADKITXLR



## ACCESSORIES



Lower cushion thickness 40 mm  
RRGTPAD028

## FIXING BRACKETS



F1



F2

## FLOOR FIXING

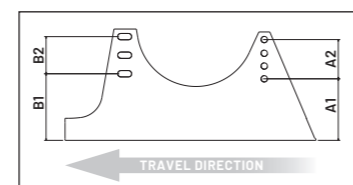

SEE SCHEME ON PAGE 68



\* Attention: this code refers to the seat excluding the pad kits. The pad kits are provided/supplied separately.

• Size: L  
• Cod: RFSEGTPAD\*



MANUFACTURER: SABELT  
MODEL: GT-PAD  
HOM. NO: CS.391.18  
FIA STANDARD: 8855-1999

# TAURUS

8855-1999

FIBERGLASS	SHELL SIZE	FIXING	FIA
	M - L - XL	BRACKETS	8855-1999

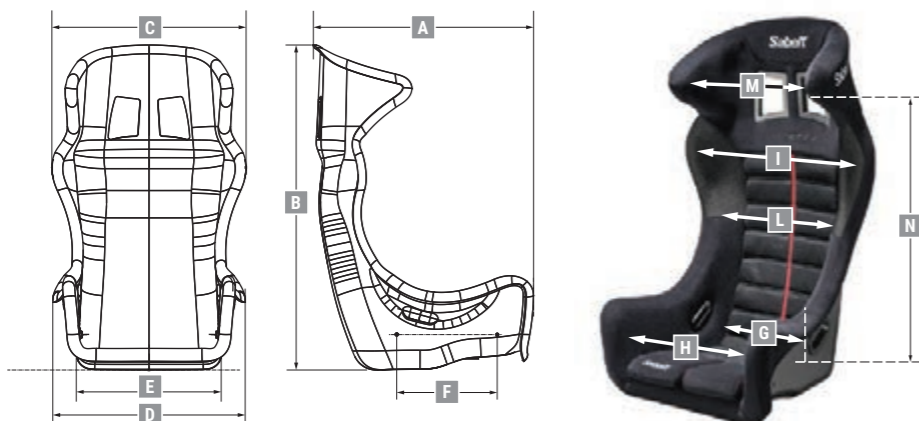

	Sizes		
	M	L	XL
<b>SHELL DIMENSIONS (mm)</b>			
A	543	550	586
B	925	979	980
C	579	582	588
D	475	481	519
E	377	392	411
F	290	290	290
⊞	8,4	9,0	9,7
<b>INTERNAL SEAT DIMENSIONS (mm)</b>			
G	300	318	326
H	364	373	393
I	486	501	512
L	345	362	393
M	341	357	394
N	685	717	716
⊞	10,5	11,4	11,4

## SPARES AND ACCESSORIES



## FIXING BRACKETS



## FLOOR FIXING

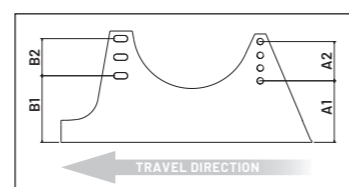

SEE SCHEME ON PAGE 68



• Size: **M**  
 • Cod: **RFSETAURUSMN**  
  
 MANUFACTURER: SABELT  
 MODEL: TAURUS TG M  
 HOM. NO: CS.368.17  
 FIA STANDARD: 8855-1999

• Size: **L**  
 • Cod: **RFSETAURUSN**  
  
 MANUFACTURER: SABELT  
 MODEL: TAURUS  
 HOM. NO: CS.346.16  
 FIA STANDARD: 8855-1999

• Size: **XL**  
 • Cod: **RFSETAURUSMAXN**  
  
 MANUFACTURER: SABELT  
 MODEL: TAURUS MAX  
 HOM. NO: CS.347.16  
 FIA STANDARD: 8855-1999

# TITAN CARBON

8855-1999

CARBON	SHELL SIZE	FIXING	FIA
	XL	BRACKETS	8855-1999



## SPARES AND ACCESSORIES



## FIXING BRACKETS



## FLOOR FIXING

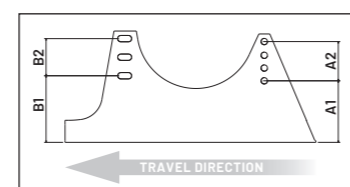

SEE SCHEME ON PAGE 68



• Size: **L**  
 • Cod: **RFSETITANCARBONN**

**FIA APPROVED**

MANUFACTURER: SABELT  
 MODEL: TITAN CARBON  
 HOM. NO.: CS.370.17  
 FIA STANDARD: 8855-1999

• Size: **XL**  
 • Cod: **RFSETITANCARBONMAXN**

**FIA APPROVED**

MANUFACTURER: SABELT  
 MODEL: TITAN CARBON  
 HOM. NO.: CS.370.17  
 FIA STANDARD: 8855-1999

# TITAN

8855-1999

FIBERGLASS	SHELL SIZE	FIXING	FIA
	XL	BRACKETS	8855-1999

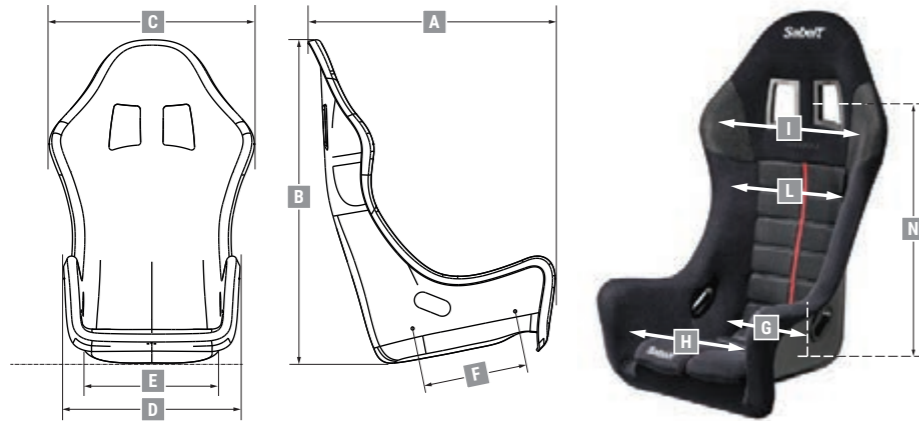

Sizes	
XL	
SHELL DIMENSIONS (mm)	
A	602
B	957
C	606
D	506
E	415
F	290
Ⓛ	7,8
INTERNAL SEAT DIMENSIONS (mm)	
G	313
H	367
I	517
L	379
M	-
N	690
Ⓛ	9,9

## SPARES AND ACCESSORIES



## FIXING BRACKETS



## FLOOR FIXING

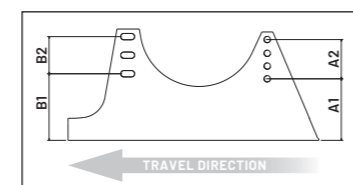

SEE SCHEME ON PAGE 68



• Size: **XL**  
• Cod: **RFSETITANMAXN**



MANUFACTURER: SABELT  
MODEL: TITAN MAX  
HOM. NO: CS.350.16  
FIA STANDARD: 8855-1999

# GT-3

8855-1999

FIBERGLASS	SHELL SIZE	FIXING	FIA
	L	BRACKETS	8855-1999

Sizes	
L	
SHELL DIMENSIONS (mm)	
A	460
B	920
C	592
D	539
E	416
F	290
📏	7,2
INTERNAL SEAT DIMENSIONS (mm)	
G	355
H	386
I	469
L	354
M	-
N	706
📏	9,8

### SPARES AND ACCESSORIES



### FIXING BRACKETS

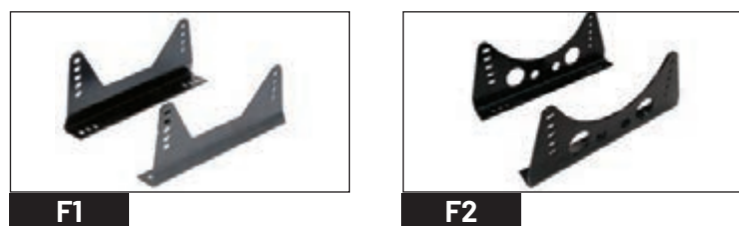

### FLOOR FIXING

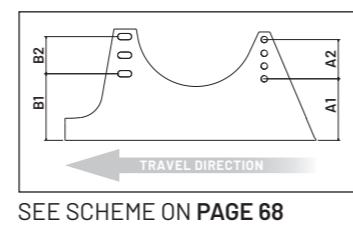

• Size: L  
• Cod: RFSEGT3N



MANUFACTURER: SABELT  
MODEL: GT-3  
HOM. NO: CS.355.17  
FIA STANDARD: 8855-1999

# RACER DUO

8855-1999

STEEL TUBE	SHELL SIZE	FIXING	FIA
	L	BRACKETS	8855-1999

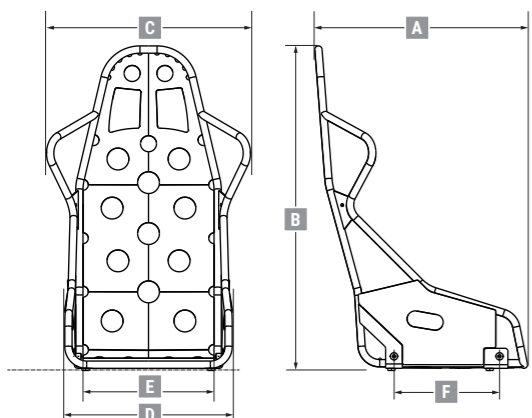

Sizes	
L	
SHELL DIMENSIONS (mm)	
A	463
B	890
C	582
D	489
E	422
F	290
⊕	10,0
INTERNAL SEAT DIMENSIONS (mm)	
G	324
H	377
I	509
L	374
M	-
N	637
⊕	12,0

## SPARES AND ACCESSORIES



## FIXING BRACKETS



## FLOOR FIXING

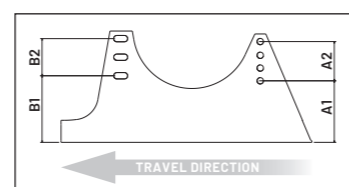

SEE SCHEME ON PAGE 68



• Size: L  
• Cod: RFSERACERN



MANUFACTURER: SABELT  
MODEL: RACER DUO  
HOM. NO: CS.387.17  
FIA STANDARD: 8855-1999

# RACEWEAR





SUITS



SHOES



GLOVES



UNDERWEAR





## FIA 8856-2018

## SUITS



HERO SUPERLIGHT TS-10



- Shell size: 44-66
- Weight: 265 g/m<sup>2</sup>
- SFI: 3.2A/5 - 3.4 available
- : available

NEW



CHALLENGE TS-2



- Shell size: 44-66
- Weight: 360 g/m<sup>2</sup>
- SFI: 3.2A/5 - 3.4 available
- : available

NEW



ROCKET TS-1



- Shell size: S-XXXL
- Weight: 400 g/m<sup>2</sup>

NEW

## UNDERWEAR



UI-600



- Balaclava: ONE SIZE
- Top/Pant: XS-XXL (slim fit)
- Socks: 38-46

NEW



UI-600 RF



- Top/Pant: S-XXXL (regular fit)

NEW



UI-200



- Balaclava: ONE SIZE
- Top/Pant: XS-XXL (slim fit)

NEW

## FIA 8856-2018

## SHOES



ZERO GRAVITY TB-11



- Shell size: 36-48

NEW



HERO PRO TB-10



- Shell size: 36-48

NEW



LASER TB-3



- Shell size: 36-48

- : available

NEW



CHALLENGE TB-2



- Shell size: 36-48

NEW



CLASSIC TB-2



- Shell size: 36-46

## GLOVES



HERO SUPERLIGHT TG-10



- Shell size: 8-12

NEW



CHALLENGE TG-2



- Shell size: 8-12

NEW



LASER TG-3



- Shell size: 9-12

- : available

NEW

## GLOVES



Z120760

- Shell size: ONE SIZE

- Hom: n/a



Z120560

- Shell size: ONE SIZE

- Hom: n/a

### MADE TO MEASURE SUIT TEMPLATE

NAME: \_\_\_\_\_ FLAG: \_\_\_\_\_

HEIGHT: \_\_\_\_\_ WEIGHT: \_\_\_\_\_

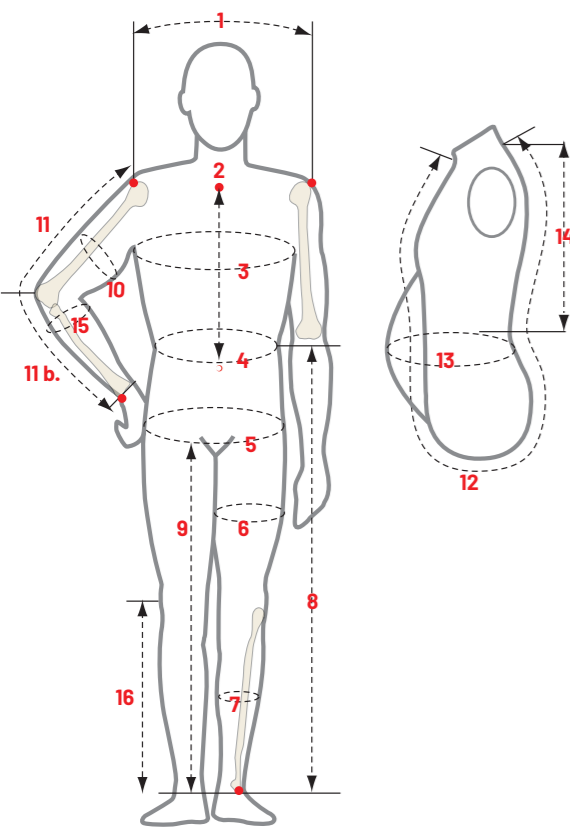

- 1 Shoulder breadth (from points of shoulders bones across back)
- 2 Body length from inside shoulder to waist
- 3 Maximum chest circumference
- 4 Waist circumference measured at the narrowest point
- 5 Hip circumference
- 6 Thigh circumference
- 7 Calf circumference
- 8 Outside leg length from waist to malleolus
- 9 Desired length from the crotch to ankle
- 10 Biceps circumference
- 11 Sleeve length from point of shoulder bone to wrist (arm bent)
- 11 b Forearm length from elbow to wrist
- 12 Crotch length from front collar bone through top of inside leg to back neck
- 13 Maximum waist circumference
- 14 Length from neck to waist
- 15 Forearm circumference
- 16 Length from the knee center to malleolus

1	4	7	10	12	15
2	5	8	11	13	16
3	6	9	11 b	14	

BELT:  YES  NO

DESIRED FIT:  SLIMFIT  REGULAR LOOSE

NASCAR BOOTCUT:  YES  NO

COOLING HOLE:  YES  NO ...if YES  LEFT  RIGHT

POCKETS:  CELL.  NORMAL  NONE

LOGOS:  PRINT  EMBROIDERY

MECHANIC FEATURES:  YES  NO



- DOUBLE BELT LOOP
- RADIO OR ACCESSORIES LOOP
- SHOULDER WIRE CORD
- BOOT CUT

### SUITS - STANDARD SIZE CHART Sizes listed are in cm and are for body measurements, not for the suit.

TS-10 (SLIM FIT) - SIZE	TS-2 (REGULAR FIT) - SIZE	CHEST	WAIST	HIPS	WEIGHT	HEIGHT	TS-1 / TM-1 SIZE
44	44	82-86	69-73	81-85	43-48	160-163	XS
46	46	86-90	73-77	85-89	49-54	164-166	
48	48	90-94	77-81	89-93	55-60	167-169	S
50	50	94-98	81-85	93-97	61-66	170-172	
52	52	98-102	85-89	97-101	67-72	173-175	M
54	54	102-106	89-93	101-105	73-78	176-179	
56	56	106-110	93-97	105-109	79-84	180-184	L
58	58	110-114	97-101	109-113	85-90	185-187	
60	60	114-118	101-105	113-117	91-96	188-190	XL
62	62	118-122	105-109	117-121	97-102	191-193	
64	64	122-126	109-113	121-125	103-108	194-196	XXL
66	66	126-130	113-117	125-129	109-114	197-199	
-	-	130-134	117-121	129-133	115-118	n/a	XXXL
-	-	134-138	121-125	133-137	119-122	n/a	

### SUITS - STANDARD SIZE CHART (WOMAN) - ON DEMAND Sizes listed are in cm and are for body measurements, not for the suit.

SIZE	SIZE	SHOULDERS	BREAST	CHEST	WAIST	HIPS	WEIGHT	HEIGHT
XS	38	35-37	78-82	74-78	58-62	82-86	40-45	154-158
	40	36-38	82-86	78-82	62-66	86-90	45-50	157-161
S	42	37-39	86-90	82-86	66-70	90-94	50-55	160-164
	44	38-40	90-94	86-90	70-74	94-98	55-60	163-167
M	46	39-41	94-98	90-94	74-78	98-102	60-65	166-170
	48	40-42	98-102	94-98	78-82	102-106	65-70	168-172
L	50	41-43	102-106	98-102	82-86	106-110	70-75	170-174
	52	42-44	106-110	102-106	86-90	110-114	75-80	173-177
XL	54	43-45	110-114	106-110	90-94	114-118	80-85	176-180
	56	44-46	114-118	110-114	94-98	118-122	85-90	179-183
XXL	58	45-48	118-122	114-118	98-102	122-126	90-95	180-184
	60	46-49	122-126	118-122	102-106	126-130	95-100	182-186

### UNDERWEAR - STANDARD SIZE CHART Sizes listed are in cm and are for body measurements, not for the underwear.

	SIZE					
UI-600 (SLIM FIT)	XS-S	M-L		XL-XXL		
UI-600 RF (REGULAR FIT)	S	M	L	XL	XXL	XXXL
UI-200 (SLIM FIT)	S	M-L		XL-XXL		
CHEST	82-90	90-102	102-114	114-122	122-130	130-138
WAIST	69-77	77-89	89-101	101-109	109-117	117-125
HIPS	81-89	89-101	101-113	113-121	121-129	129-137
HEIGHT	162-166	167-175	176-187	188-193	194-199	n/a
WEIGHT (kg)	43-54	55-72	73-90	91-102	103-114	115-122

### SHOES, SOCKS, GLOVES - STANDARD SIZE CHARTS

SHOES				SOCKS
FOOT LENGTH (cm)	EU SIZE	US SIZE	UK SIZE	SIZE
23	36	4	3,5	38/39
23,5	37	5	4	
24	38	6	5	
25	39	6,5	5,5	
25,5	40	7,5	6,5	40/41
26	41	8	7	
27	42	9	8	42/43
27,5	43	10	9	
28	44	10,5	9,5	44/45
29	45	11,5	10,5	
29,5	46	12	11	
30	47	13	12	
31	48	14	13	46

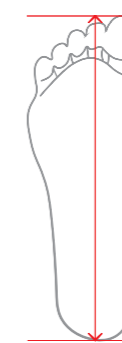

GLOVES		
HAND DIMENSIONS (cm)	SIZE	
20-21	8	XS
21-22	9	S
22-23	10	M
23-24	11	L
24-25	12	XL



- DOUBLE BELT LOOP
- RADIO OR ACCESSORIES LOOP
- SHOULDER WIRE CORD
- BOOT CUT

# SUITS



## HERO SUPERLIGHT TS-10

Size	Sandwich weight	FIA	Available SFI	Made in Italy	Available	EXCLUSIVE TECHNICAL SOLUTION MADE IN SABELT
44-66	265 g/m <sup>2</sup>	8856-2018	3.2A/5 - 3.4		FRIENDLY	

### NEW FITTING



#### COLOURS/CODES

	RFTITS10BLAZ..
	RFTITS10NRBI..
	RFTITS10RSBI..
	RFTITS10BINR..
	RFTITS10NRGL.. <b>NEW</b>



MANUFACTURER: SABELT  
MODEL: HERO SUPERLIGHT TS-10  
HOM. NO: DC.108.20-O  
FIA STANDARD: 8856-2018



# CHALLENGE TS-2

Size	Sandwich weight	FIA	Available SFI	Made in Italy	Available	EXCLUSIVE TECHNICAL SOLUTION MADE IN SABELT
44-66	360 g/m <sup>2</sup>	8856-2018	3.2A/5 - 3.4		FRIENDLY	



COLOURS/CODES	
	RFTITS2NR..
	RFTITS2RS..
	RFTITS2BI..
	RFTITS2BL.. <b>NEW</b>
	RFTITS2NRGFL.. <b>NEW</b>



MANUFACTURER: SABELT  
MODEL: CHALLENGE TS-2  
HOM. NO: DC.116.21-O  
FIA STANDARD: 8856-2018

# ROCKET TS-1

**NEW**

Size	Sandwich weight	FIA	Made in Italy	EXCLUSIVE TECHNICAL SOLUTION MADE IN SABELT
S-XXXL	400 g/m <sup>2</sup>	8856-2018		



COLOURS/CODES	
	RFTITS1NR..





MANUFACTURER: SABELT  
MODEL: TS-1  
HOM. NO: DC.xxx.xx-O  
FIA STANDARD: 8856-2018

## SHOES



## ZERO GRAVITY TB-11

NEW

Size	FIA	Made in Italy	 EXCLUSIVE TECHNICAL SOLUTION MADE IN SABELT
36-48	8856-2018		





## COLOURS/CODES

	RFTB11NR..
---	------------







MANUFACTURER: SABELT  
MODEL: TB-11  
HOM. NO: DC.xxx.xx-Z  
FIA STANDARD: 8856-2018

# HERO PRO TB-10

Size	FIA	Made in Italy	 EXCLUSIVE TECHNICAL SOLUTION MADE IN SABELT
36-48	8856-2018		



COLOURS/CODES	
	RFTB10NR..
	RFTB10RS..
	RFTB10BL..
	RFTB10BI..



OPTIONAL



**RCTB10SOL..**  
Reinforced Insole  
**NEW**





MANUFACTURER: SABELT  
 MODEL: HERO PRO TB-10  
 HOM. NO: DC.098.20-Z  
 FIA STANDARD: 8856-2018

# LASER TB-3

Size	FIA	Made in Italy	Available	 EXCLUSIVE TECHNICAL SOLUTION MADE IN SABELT
36-48	8856-2018		 FRIENDLY	





COLOURS/CODES	
	RFTB03LASERNR..
	RFTB03LASERBI.. <b>NEW</b>





MANUFACTURER: SABELT  
 MODEL: LASER TB-3  
 HOM. NO: DC.115.21-Z  
 FIA STANDARD: 8856-2018

# CHALLENGE TB-2

Size	FIA	Made in Italy	 EXCLUSIVE TECHNICAL SOLUTION MADE IN SABELT
36-48	8856-2018		





COLOURS/CODES	
	RFTB02NR..
	RFTB02RS.. <b>NEW</b>
	RFTB02BL.. <b>NEW</b>





**APPROVED**  
 MANUFACTURER: SABELT  
 MODEL: TB-2  
 HOM. NO: DC.118.21-Z  
 FIA STANDARD: 8856-2018

# CLASSIC TB-2

Size	FIA	Made in Italy	 EXCLUSIVE TECHNICAL SOLUTION MADE IN SABELT
36-46	8856-2018		



COLOURS/CODES	
	RFTB02CLASSICNR..
	RFTB02CLASSICRS..



**APPROVED**  
 MANUFACTURER: SABELT  
 MODEL: TB-2  
 HOM. NO: DC.118.21-Z  
 FIA STANDARD: 8856-2018

# GLOVES

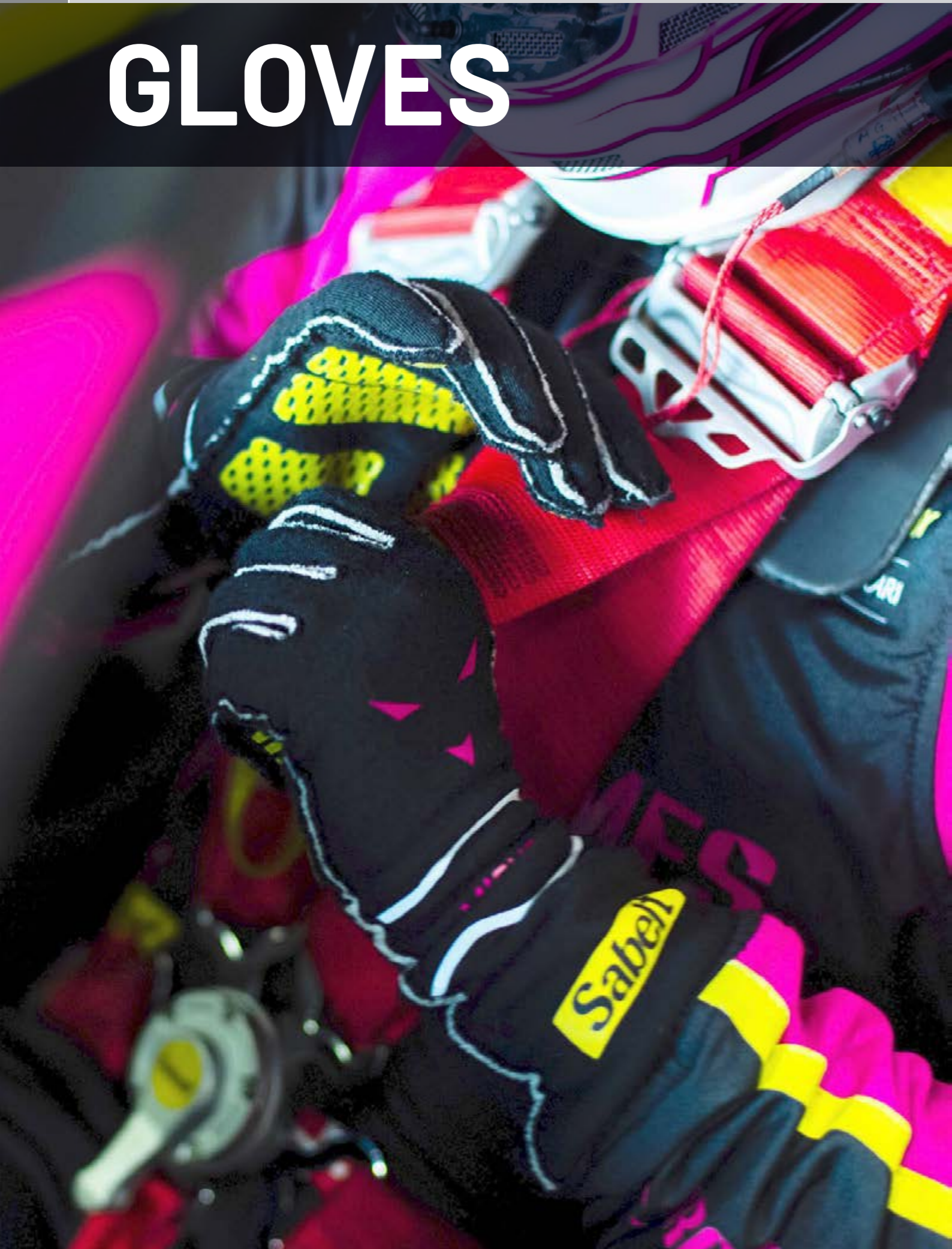

## HERO SUPERLIGHT TG-10

Size	FIA	Made in Italy
8-12	8856-2018	



COLOURS/CODES	
	RFTG10NR..
	RFTG10RS..
	RFTG10BL..
	RFTG10BI..
	RFTG10GFL.. <b>NEW</b>

**APPROVED**

MANUFACTURER: SABELT  
 MODEL: HERO SUPERLIGHT TG-10  
 HOM. NO.: DC.081.20-G  
 FIA STANDARD: 8856-2018





# LASER TG-3

Size	FIA	Made in Italy	Available	EXCLUSIVE TECHNICAL SOLUTION MADE IN SABELT
9-12	8856-2018		FRIENDLY	



COLOURS/CODES	
	RFTG03LASERNR..
	RFTG03LASERGFL.. <b>NEW</b>



**APPROVED**  
 MANUFACTURER: SABELT  
 MODEL: LASER TG-3  
 HOM. NO: DC.122.21-G  
 FIA STANDARD: 8856-2018

# CHALLENGE TG-2

Size	FIA	Made in Italy
8-12	8856-2018	



COLOURS/CODES	
	RFTG02NR..
	RFTG02RS.. <b>NEW</b>
	RFTG02BL.. <b>NEW</b>



**APPROVED**  
 MANUFACTURER: SABELT  
 MODEL: CHALLENGE TG-2  
 HOM. NO: DC.113.20-G  
 FIA STANDARD: 8856-2018

# UNDERWEAR



## UI-600

FIA  
8856-2018

EXCLUSIVE TECHNICAL SOLUTION  
MADE IN SABELT



<p>BALACLAVA</p> <p><input type="checkbox"/> RFUI600BALBI</p> <p><input checked="" type="checkbox"/> RFUI600BALNR</p> <p>Sizes: ONE SIZE</p>	<p>TOP <b>NEW FITTING</b></p> <p><input type="checkbox"/> RFUI600TOPBI.. <b>NEW</b></p> <p><input checked="" type="checkbox"/> RFUI600TOPNR.. <b>NEW</b></p> <p>Sizes: XS-XXL</p>	<p>PANT</p> <p><input type="checkbox"/> RFUI600PANTBI..</p> <p><input checked="" type="checkbox"/> RFUI600PANTNR..</p> <p>Sizes: XS-XXL</p>	<p>SOCK</p> <p><input type="checkbox"/> Z150UI600SOCKSB..</p> <p><input checked="" type="checkbox"/> Z150UI600SOCKSN..</p> <p>Sizes: 39-46</p>
--	---	---	--

<p><b>FIA APPROVED</b></p> <p>MANUFACTURER: SABELT MODEL: UI-600 BALACLAVA HOM. NO: DC.099.20-B FIA STANDARD: 8856-2018</p>	<p><b>FIA APPROVED</b></p> <p>MANUFACTURER: SABELT MODEL: UI-600 TOP HOM. NO: DC.100.20 -T FIA STANDARD: 8856-2018</p>	<p><b>FIA APPROVED</b></p> <p>MANUFACTURER: SABELT MODEL: UI-600 PANT HOM. NO: DC.101.20-L FIA STANDARD: 8856-2018</p>	<p><b>FIA APPROVED</b></p> <p>MANUFACTURER: SABELT MODEL: UI-600 SOCKS HOM. NO: DC.088.20-S FIA STANDARD: 8856-2018</p>
---	--	--	---

# UI-600 RF

**NEW**

FIA  
8856-2018

EXCLUSIVE TECHNICAL SOLUTION  
MADE IN SABELT



TOP
<input type="checkbox"/> RFUI600TOPRFBI..
<input checked="" type="checkbox"/> RFUI600TOPRFNR..
Sizes: S-XXXL

PANT
<input type="checkbox"/> RFUI600PANTRFBI..
<input checked="" type="checkbox"/> RFUI600PANTRFNR..
Sizes: S-XXXL



# UI-200

**NEW**

FIA  
8856-2018

EXCLUSIVE TECHNICAL SOLUTION  
MADE IN SABELT



BALACLAVA
<input type="checkbox"/> RFUI200BALBI
<input checked="" type="checkbox"/> RFUI200BALNR
Sizes: ONE SIZE

TOP
<input type="checkbox"/> RFUI200TOPBI..
<input checked="" type="checkbox"/> RFUI200TOPNR..
Sizes: XS-XXL

PANT
<input type="checkbox"/> RFUI200PANTBI..
<input checked="" type="checkbox"/> RFUI200PANTNR..
Sizes: XS-XXL



# CREW



## ROCKET TM-1

NEW

Size	Sandwich weight	Hom.	Made in Italy	Colour/Code	
S-XXXL	400 g/m <sup>2</sup>	n/a			RFTUTMINR..

EXCLUSIVE TECHNICAL SOLUTION  
MADE IN SABELT



CODE	SIZE	HOM.
Z120560	ONE SIZE	n/a



Protective gloves and arm protections against mechanical and thermal risks. Cotton and Kevlar fabric. Protects till 300° C. In compliance with European directives: -89/686 (dexterity 4) EN420:2003, -EN388:2003. Cut resistance (5/5). Abrasion resistance (2/4). Tearing resistance (4/4). Flammability resistance (4/4). Heat contact resistance (2/4).

CODE	SIZE	HOM.
Z120760	ONE SIZE	n/a



# ABARTH COLLECTION

**NEW**



**Only the best become Abarth**

We choose our partners with the same care that we use to tune every single Abarth. That's why only brands who share our values, passion for competition and determination to outdo themselves in every daily challenge enter our "workshops".



Size	FIA	Code
XS-XXL	8856-2018	RFUI200TOPABBI..

**FIA APPROVED**  
 MANUFACTURER: SABELT  
 MODEL: UI-200 TOP  
 HOM. NO: DC.XXX.XX-T  
 FIA STANDARD: 8856-2018



Size	FIA	Code
46-66	8856-2018	RFTUTS2ABRS..

**FIA APPROVED**  
 MANUFACTURER: SABELT  
 MODEL: CHALLENGE TS-2  
 HOM. NO: DC.116.21-O  
 FIA STANDARD: 8856-2018



Size	FIA	Code
8-12	8856-2018	RFTG02ABRS..

**FIA APPROVED**  
 MANUFACTURER: SABELT  
 MODEL: CHALLENGE TG-2  
 HOM. NO: DC.113.20-G  
 FIA STANDARD: 8856-2018



Size	FIA	Code
36-46	8856-2018	RFTB02CLASSICABRS..

**FIA APPROVED**  
 MANUFACTURER: SABELT  
 MODEL: CHALLENGE TB-2  
 HOM. NO: DC.118.21-Z  
 FIA STANDARD: 8856-2018



# STEERING WHEELS



**SW-833**  
 Ø 330 mm  
 CODE RFV02010X  
**30% LIGHTER**



**SW-633**  
 Ø 330 mm  
 CODE RFV02010X  
**NO STITCHING**



**SW-465**  
 Ø 350 mm  
 CODE RFV02009X  
**NO STITCHING**



**SW-732** **NEW**  
 Ø 320 mm  
 CODE RFV02038  
**NO STITCHING**



**SW-733**  
 Ø 330 mm  
 CODE RFV02007X  
**NO STITCHING**



**SW-635**  
 Ø 350 mm  
 CODE RFV02007X  
**NO STITCHING**



**SW-390**  
 Ø 350 mm  
 CODE RFV02005X  
**NO STITCHING**



# ACCESSORIES





**QUICK RELEASE**



**M220SR6GRN**  
Quick release steering boss for group N cars, conformity to FIA regulation, compatible with all Sabelt 6-slot steering wheels.



**M220SR6B**  
Quick release steering boss to be welded for Touring/Rally cars, conformity to FIA regulation, compatible with all Sabelt 6-slot steering wheels.

**TOW STRAP**

Length: 260 mm.  
Hole diameter: 15,5 mm.



CCAC0023\_A   CCAC0027\_A   CCAC0024\_A   CCAC0028\_A   CCAC0026\_A   CCAC0025\_A

**DOOR STRAP**



**CCAC0043\_A**  
Door strap to be fixed on the door panel. Length: 220 mm. Hole diameter: 9.5 mm.

**NOTEBOOK**



**Z240600**  
Size 22 x 17,5 cm

**CO-DRIVER POCKET**

Nomex fabric.  
Velcro locking.  
Size 17 x 23 cm.



RFTINAVRS   RFTINAVBR   RFTINAVBI   RFTINAVNR

**CO-DRIVER BAG**

Co-Driver bag, very thin. Velcro back panel for door bars universal fixation, phone compartment and external pockets.



COLOURS/CODES		
	RFBS0039	27x36x7 cm

**SUIT BAG**



COLOURS/CODES		
	RFBS0015	46x34x10 cm

**WEEKEND BAG**



COLOURS/CODES		
	RFBS0016NR	55x37x23 cm
	RFBS0016RS	

## K-WAY



COLOURS/CODES	Sizes
 RSPW014BL...	XS-XXL

Regular fit

Nylon ripstop  
water repellent

Taped seams

## PININFARINA PF-1



COLOURS/CODES	Sizes
 RFTBR4PIN..	39-45

Shoe born from the collaboration between Sabelt and Pininfarina. The union of two Italian excellences to create an exclusive and iconic product. This model is characterized by Sabelt's Racing experience and by a unique and cool design which distinguishes Pininfarina's style.

