

# Technical Bulletin 044 – Zero 275 1.4-4.03m<sup>3</sup> Installation Guide

Rev2 12/12/2018

The Lifeline Zero 275 extinguisher range (UK Patent Application No. GB1813948.5) is homologated to FIA8865-2015 standard. These systems provide a high level of protection for you and your vehicle and have been extensively tested by Lifeline, the FIA, and BSI to meet the FIA 8865-2015 requirements. A plumbed-in fire extinguisher system is mainly designed to delay the development of the fire and consequently give the driver more time to exit the car. This system is not designed to put out the fire and prevent the car from burning.

The information below provides a guide to installing your chosen system. Unfortunately, due to the variety of vehicles being raced the exact location of the components of the systems cannot be fully defined by Lifeline; this document provides “best practise” advice suitable for the vast majority of vehicles. If you feel that your installation cannot follow these guidelines, please contact Lifeline Technical for further guidance.

*Fully read and understand the instructions below before starting installation. Plan your installation carefully referring to the tables below and the system drawings. Do not cut the supplied tubing or the plug and lead sets until you are certain of the location of the cylinder, connectors, nozzles, switches and power pack.*

Other References	
TB001	System Care, maintenance and Service
TB006	Monnex MSDS
TB046	Coldfire MSDS
TB045	Zero 275 – Kit Content and Spares

## Section 1 – Cylinder, Bracket and Straps

Item	Fixing Type and No.	Location and Fitting Guide
<b>Cylinder and Bracket -</b>	4xM6 nut, bolt and washers. Vibration washers and/or Nylocs are highly recommended. The use of self-tapping screws is not permitted. Anti-Vibration Mounts on all 4 fixing points are highly recommended. It is permitted to replace the bracket and straps with your own design provided it conforms to the requirements of Art. 253.	Mount transversally in the car and within the safety cell/roll cage. For recommended location, refer to Section 6.  Homologation label and FIA Hologram must be visible for scrutineering. Avoid positions where cylinder is likely to be damaged, abraded or be exposed to excessive heat.

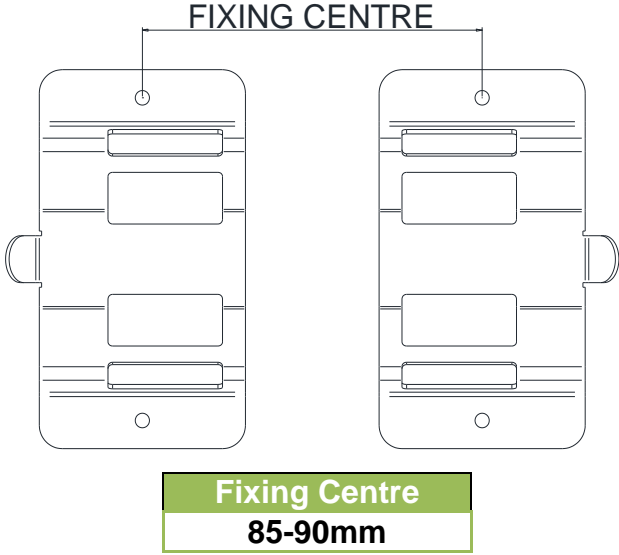
Item	Fixing Type and No.	Location and Fitting Guide
 <p style="text-align: center;">Figure 1 – Bracket Fixing Centres</p>		
Straps	2No. T-Bolt straps/cylinder	Thread through provided slots in brackets and around the cylinder. Tighten T-bolts taking care not to over tighten and damage the cylinder.

## Section 2 – Delivery Network – Tube and Connectors

Item and System Type	Fixing Type and No.	Location and Fitting Guide
8mm Engine Bay & 10mm Cockpit Tube	Cable ties or P'clips as required	<p>Referring to section 3 and 6, cut tube to pre-measured length using a dedicated tube cutter, ensuring that there are no sharp edges and that the tube remains circular. Do not use a hack saw or similar tool; this will leave a jagged edge which will damage seals in the connectors.</p> <p>Form the tube using a pipe bender taking care not to create a kink which could restrict flow (hand bending is possible but not preferred). Minimum bend radius of the tube is shown below. <b>Use as few bends as possible for smooth flow of suppressant and best performance; this is particularly important for the cockpit tube which should be as straight as</b></p>

Item and System Type	Fixing Type and No.	Location and Fitting Guide						
		<p>possible, with large bends where necessary, to the nozzle.</p> <p>The pipe lengths to each of the engine bay nozzles should be kept as equal as possible for best suppressant discharge.</p> <table border="1"> <thead> <tr> <th>Tube Ø</th> <th>Minimum Bend Radius</th> </tr> </thead> <tbody> <tr> <td>8mm</td> <td>30mm when using pipe bending tool</td> </tr> <tr> <td>10mm</td> <td>75mm when using pipe bending tool</td> </tr> </tbody> </table> <p>Secure the tube using cable ties and saddles or P'clips.</p>	Tube Ø	Minimum Bend Radius	8mm	30mm when using pipe bending tool	10mm	75mm when using pipe bending tool
Tube Ø	Minimum Bend Radius							
8mm	30mm when using pipe bending tool							
10mm	75mm when using pipe bending tool							
<b>Connectors</b>	N/A	<p>The engine bay nozzles are connected to an equal cross push fit connector. Push the pipes firmly into the connector ensuring they are fully inserted past the internal o'ring seal. The application of a light assembly lubricant on the end of each pipe can aid fitting.</p> <p>Pipes passing through a bulkhead must be protected with a rubber grommet.</p>						

## Section 3 – Nozzles

The Cockpit Nozzle discharges a dry powder suppressant which floods the cockpit, the nozzle is labelled to show correct orientation and should be mounted centrally in the vehicle. The 3 Engine nozzles allow for positioning of 2 nozzles on either side of the engine and a further nozzle for specific targeting of likely ignition sources. Consideration should be given to location of the engine nozzles for best coverage of the engine from both sides.

Nozzle Type	Fixing Type and No.	Location
<b>Cockpit Nozzle</b>	Floor mounted, 4x M5 Cap Head bolts	The nozzle must be located centrally in the vehicle as shown in Section 6. First fix the RED base part of the nozzle using 4x M5 Cap Head bolts orientating the connector towards the cylinder location. Fit the centre and top of the nozzle to the base using the supplied M3 Cap Head screws (2Nm max). Pipe is connected to the 10mm push fit connector.

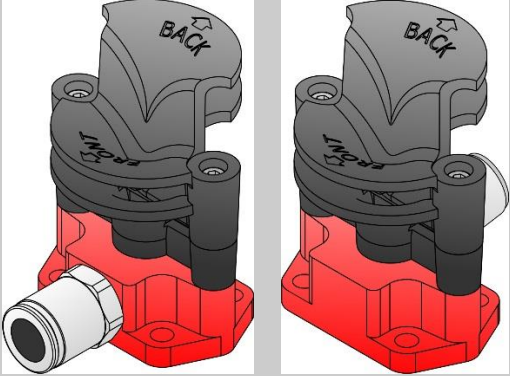
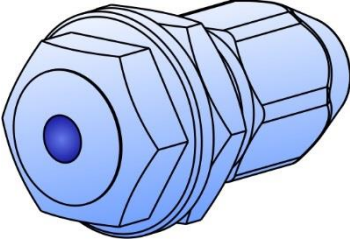
Nozzle Type	Fixing Type and No.	Location
		<p>The nozzle discharges to the front and back of the car and is marked to show the correct orientation. Excessive obstruction could reduce the effectiveness of the extinguisher.</p>  <p>Figure 2 – Cockpit Nozzle showing 10mm connector on either side</p>
<b>Engine Nozzles</b>	Fabricated bracket to suit	<p>Locate 2 of the engine bay nozzles either side of the engine, either front and back of the engine bay for a transverse engine or either side for a longitudinal engine. The 3<sup>rd</sup> nozzle should be targeted at likely ignition sources.</p>  <p>Figure 3 – Engine Nozzle</p>

## Section 4 – Activation

Item	Fixing Type and No.	Location
<b>Power Pack</b>	4No. M4 Countersunk screw and nuts	The power pack must be located where it can be reached and operated by the driver/co-pilot. In the majority of cars this will be on the centre of the dash or centre console area.

Item	Fixing Type and No.	Location
		Ensure that the LED indicator lights are visible to the driver and that cables are routed so that they cannot be accidentally damaged.
<b>Activation Switches</b>	Ø13.6mm hole and supplied lock nut	<p>Locate one switch in the cockpit where it can be reached and activated by the driver &amp; co-pilot when seated with harnesses on.</p> <p>Locate the second switch externally directly next to the electrical cut-off switch in accordance with FIA regulation.</p>
<b>Plug and Leads</b>	Cable ties as required	<p>Plug and lead sets have colour coded cores to identify which connection on the extinguisher they go to. Refer to Section 6.</p> <p>Locate each plug and lead as required between Power Pack, Activation Switches and Extinguisher. Solder joints, sealing with glue lined heat shrink to protect from water ingress. Pay attention to the joints at switches and cover the pins with glue lined heat shrink to prevent moisture ingress and prevent accidental short circuits.</p> <p>Refer to system schematic in Section 6.</p>

## Section 5 – System Checking

Item	Procedure
<b>Power Pack</b>	<ol style="list-style-type: none"> <li>1. Fit the supplied Alkaline PP3 battery to the power pack (<i>Lifeline recommend removing the battery from the power pack in between events</i>)</li> <li>2. Connect all plug and leads once they have been fully assembled following the instruction in Section 4. and diagram in Section 6.</li> <li>3. Ensure the two position toggle switch on the power pack is in the TEST position</li> <li>4. Press one of the two activation switches. The power pack then performs automatic checks of the battery condition and wiring loom</li> <li>5. If the system is correctly wired and the battery condition is good, the AMBER LED will illuminate for ~5 seconds and then go out.</li> <li>6. If the AMBER LED flashes, there is a problem.</li> <li>7. Error codes are: -             <ol style="list-style-type: none"> <li>a. 2 flashes = Battery problem – replace battery</li> <li>b. 3 flashes = Circuit problem – check plug and lead sets and activation switches</li> </ol> </li> <li>8. Once the system has confirmed that it is working correctly (no error codes), move the switch to the ARMED position. The RED LED will now flash every 3 seconds</li> </ol>

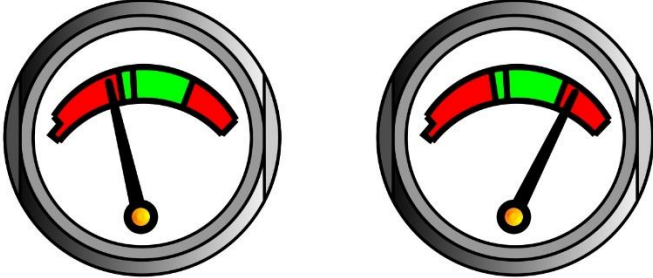
Item	Procedure
<b>Extinguisher</b>	9. The system continuously monitors the battery and circuit, if an error is found the RED LED will cease to flash
	<ol style="list-style-type: none"> <li>1. Check that the cylinder is in date and has been serviced every two years as required</li> <li>2. Check the weight of the extinguisher against that shown on the serial label. Lifeline use regularly calibrated highly accurate scales and it can be expected that some variance will be found from the weight as shown when using other equipment</li> <li>3. Check the pressure gauges are in the green area of the scale. Some fluctuation can be observed in high and low temperatures, this is normal.</li> </ol> <div style="text-align: center;">  <p>Extinguisher systems with a pressure gauge showing the above readings shall be considered OK</p>  <p>Extinguisher systems with a pressure gauge showing the above readings shall be considered NOT OK (ref FIASDH-17-010)</p> </div>

## Section 6 – System Illustrations

Figure 4 – Engine Nozzle Locations

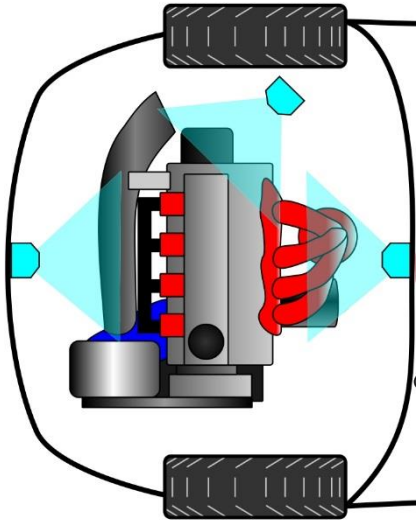

Transverse Engine

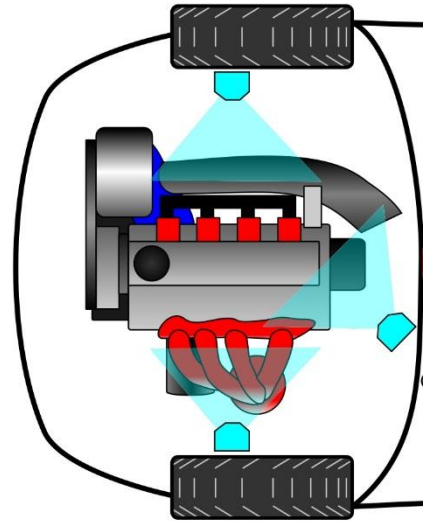

Longitudinal Engine

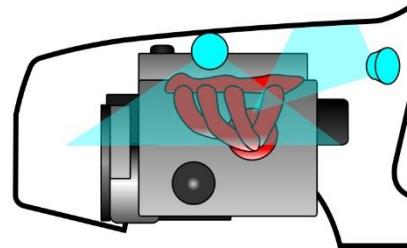
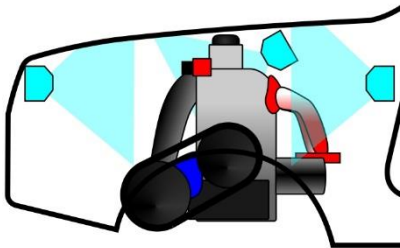

Figure 5 - Cockpit Nozzle Location/Orientation

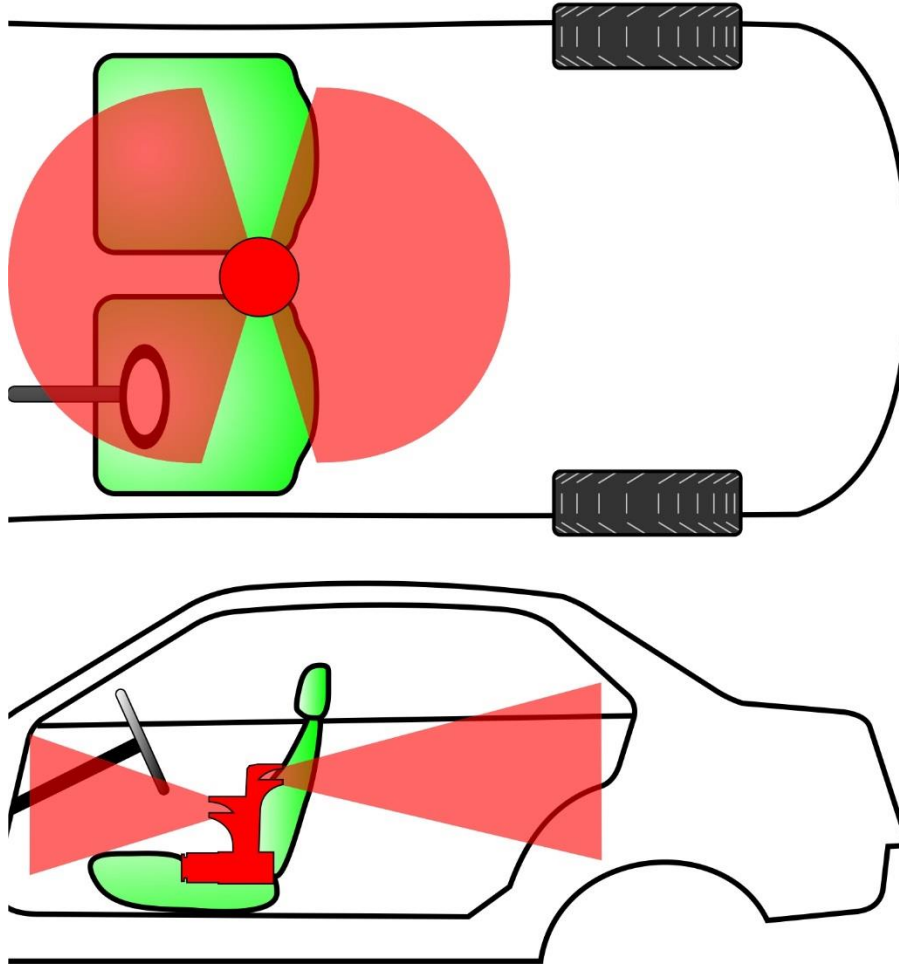
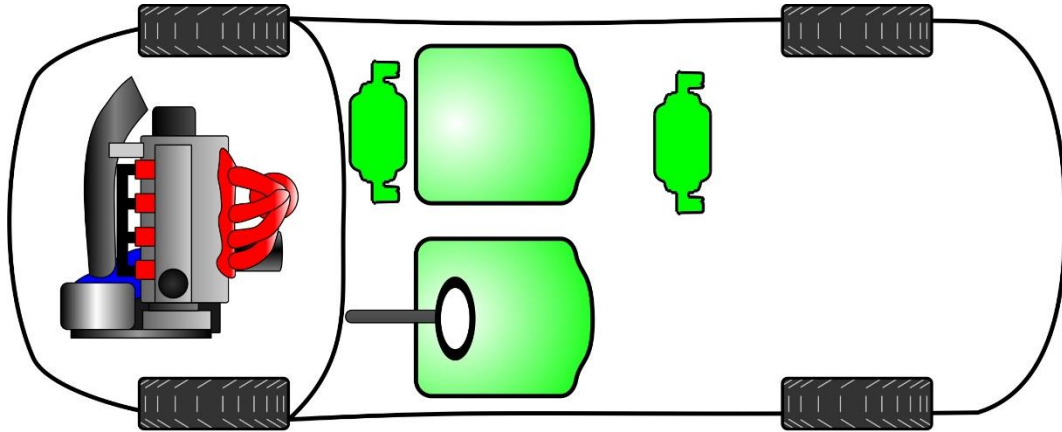



Figure 6 – Extinguisher Location



Cylinder Location is free within the cockpit volume but should ideally be mounted transversely and **MUST** be away from strong heat sources

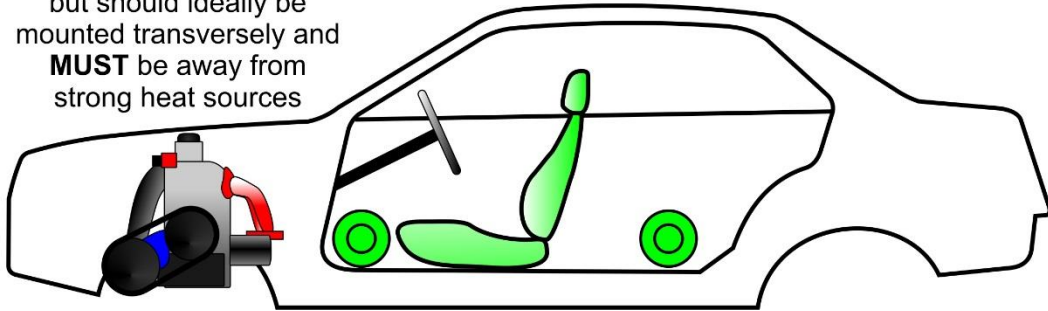
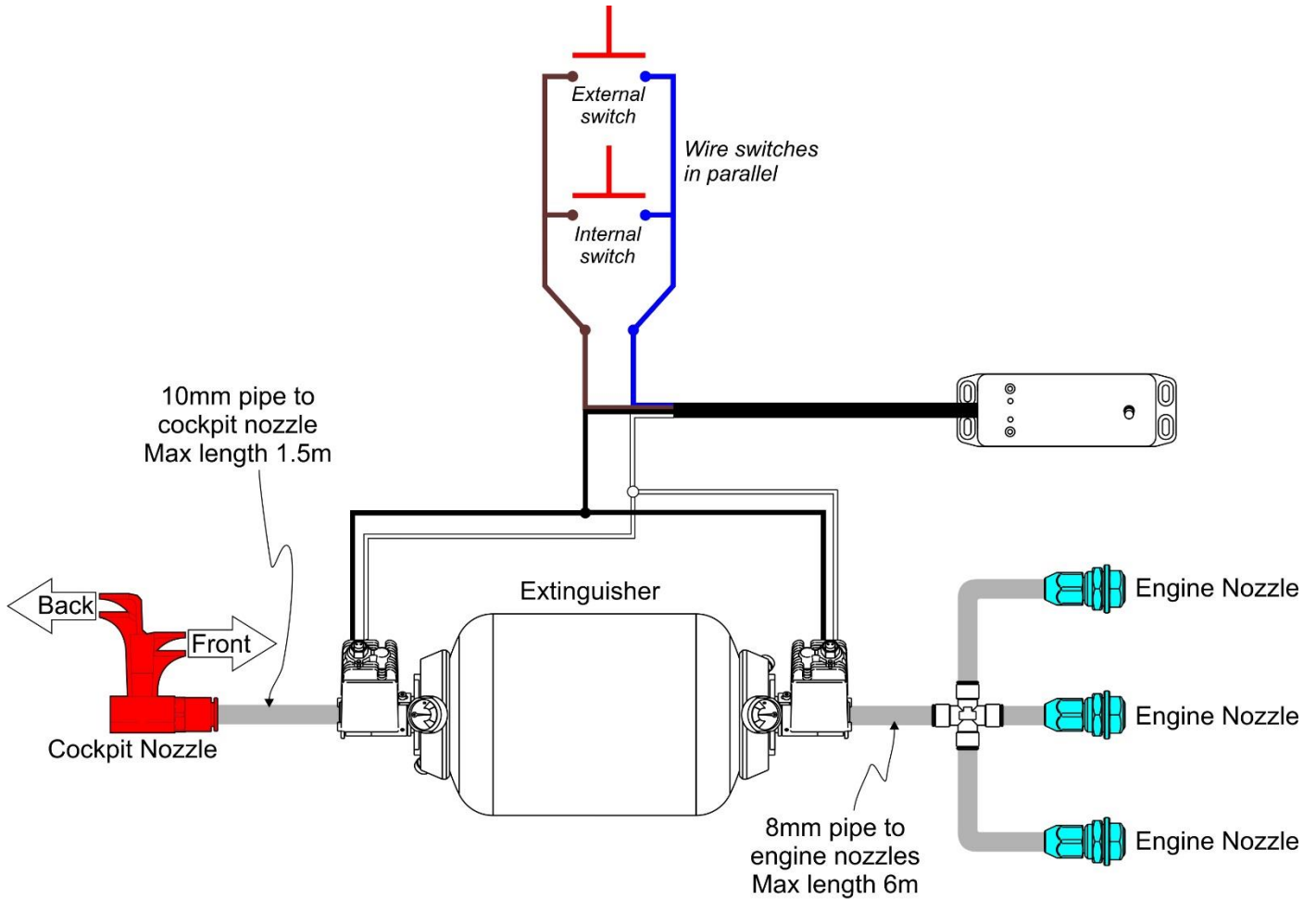

Figure 7 – System Schematic



## WIRING COLOURS

- 1 - **BROWN** = SWITCH
- 2 - **BLUE** = SWITCH
- 3 - **BLACK** = EXTINGUISHER
- 4 - **WHITE** = EXTINGUISHER

## Section 7 – Cleaning After Discharge

Item	Cleaning Equipment	Instruction
Cockpit	Vacuum Cleaner Moist cloth or cleaning wipe	After discharge, cleaning should be carried out using a vacuum cleaner to remove suppressant. The remaining residue can be removed using a moist cloth or cleaning wipe.
Engine	Water Hose	After discharge, cleaning should be carried out using water from a hose.



<b>System Part Number</b>	
<b>System Serial Numbers</b>	
<b>Date of Manufacture</b>	
<b>Service 1 Date</b>	
<b>Service 2 Date</b>	
<b>Service 3 Date</b>	
<b>Service 4 Date</b>	
<b>Service 5 Date</b>	
<b>Notes</b>	

## Notes

## Notes

# 1. INSTALLATION DU SYSTEME D'EXTINCTION / FIRE EXTINGUISHER SYSTEM INSTALLATION

## 101. INSTALLATION DANS L'HABITACLE / COCKPIT INSTALLATION

- a) Emplacement et orientation du corps

*Location and orientation of body*

Transversally, and within the safety cell/roll cage

- b) Emplacement et orientation des buses

*Location and orientation of nozzles*

Aimed as shown in E1-2 below

- c) Précaution à prendre lors de l'installation du système

*Special care to take with the installation of the system*

**Ensure nozzle is not excessively obstructed. Ensure cylinder is not positioned where it could be damaged or exposed to extreme heat**  
**See Lifeline Technical Bulletin 044 for detailed installation instructions**

E1-1) Installation dans l'habitacle (emplacement et orientation du corps)

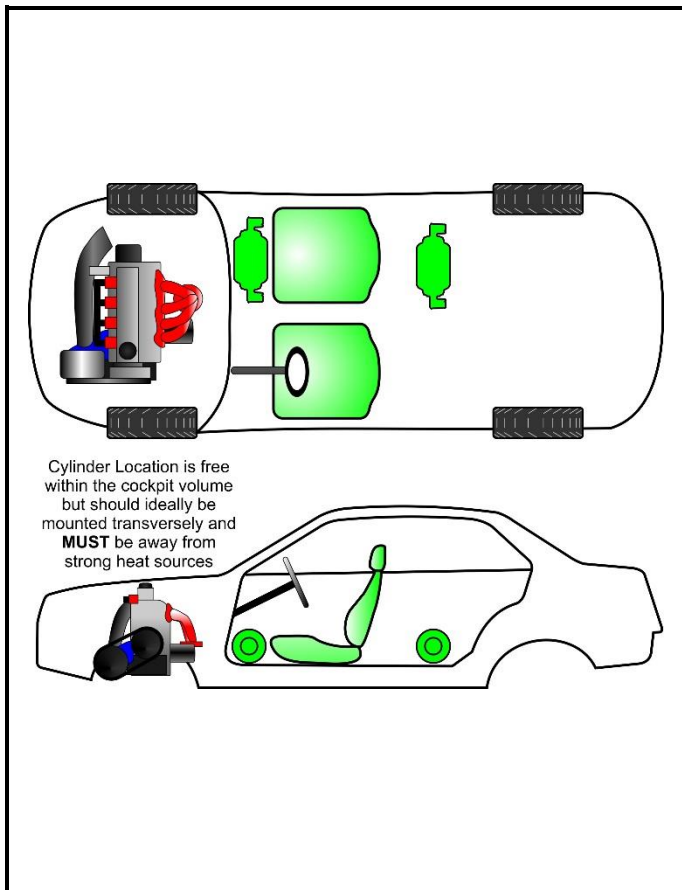

E1-2) Installation dans l'habitacle (emplacement et orientation des buses)

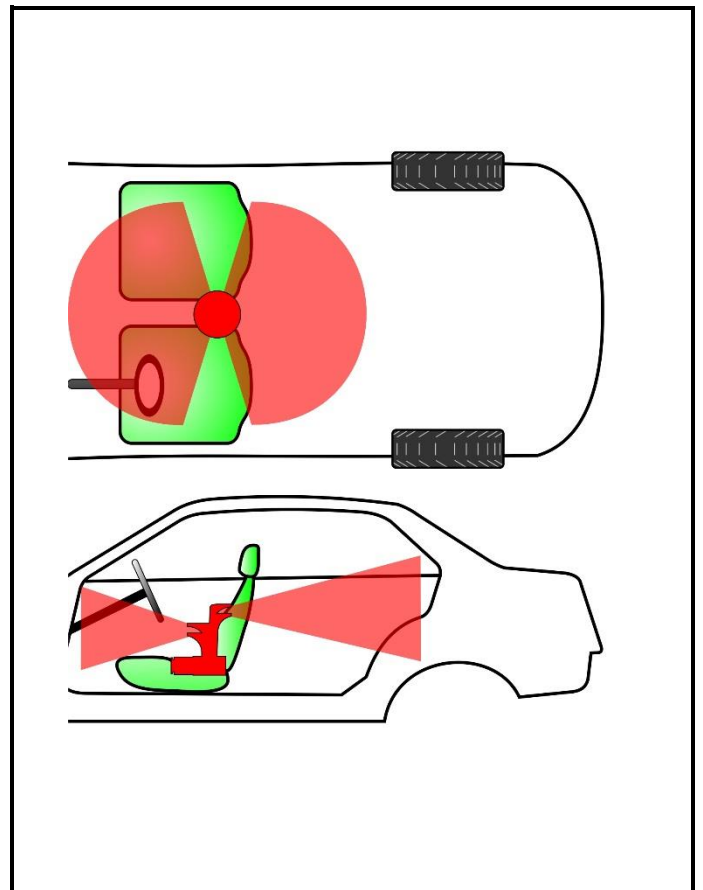

102. INSTALLATION DANS LE MOTEUR / ENGINE INSTALLATION

a) Emplacement et orientation du corps

*Location and orientation of body*

**Transversally, and within the safety cell/roll cage**

b) Emplacement et orientation des buses

*Location and orientation of nozzles*

**2 nozzles on either side of the engine, 3<sup>rd</sup> nozzle targeted at likely sources of ignition**

c) Précaution à prendre lors de l'installation du système

*Special care to take with the installation of the system*

**Nozzles must not be obstructed in any way. See Lifeline Technical Bulletin 044 for detailed installation instructions**

E2-1) Installation dans le moteur (emplacement et orientation du corps)

*Engine installation (location and orientation of body)*

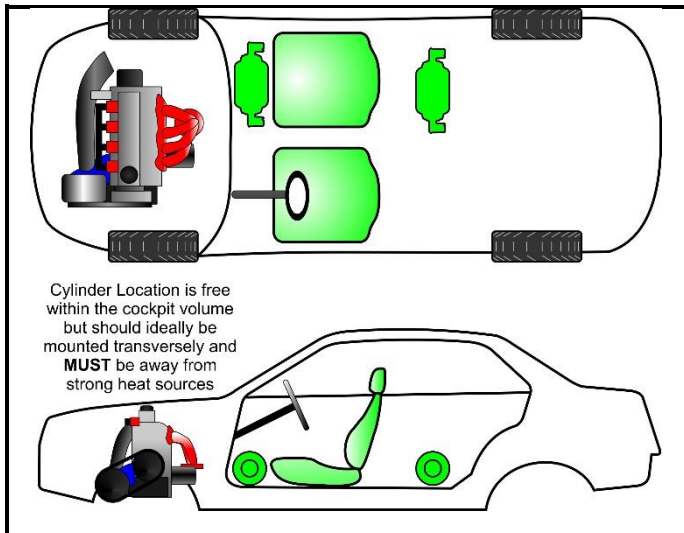

E2-2) Installation dans le moteur (emplacement et orientation des buses)

*Engine installation (location and orientation of nozzles)*

